



User manual

FirePro V4

Type: HW V4.4 SW V5.4

Version: 20230405

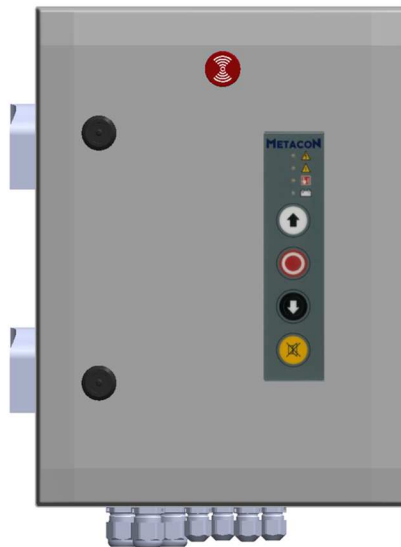

PLEASE CAREFULLY READ THIS USER MANUAL BEFORE YOU USE THE CONTROLLER.

STORE THIS INFORMATION SO THAT IT CAN BE REFERENCED IN THE FUTURE!

© 2022 RDA-BV.

This manual is translated from the original Dutch manual, In the event of discrepancies between the two, the Dutch version shall prevail. Subject to changes and typing errors.

The information in this manual is subject to change and can be revised if necessary. No rights can be claimed from the provided information.

All rights reserved. All mentioned trademarks are the property of their respective owners.

No part of this publication can be reproduced and/or disclosed by way of printing, photocopy, microfilm or any other means whatsoever without receiving written consent from RDA-BV..

RDA-BV.
Sporakkerweg 6
5071 NC Udenhout

info@rda-bv.nl
www.rda-bv.nl

Item no. : 714487.000001

Foreword

1. Foreword

This manual is intended as a guide when using the FirePro controller in combination with a “Fail-safe” drive unit type FS by GFA Elektromaten.

We would like to thank you for working with us, and for the trust that you have placed in our product.

2. Using the manual

Before using the controller, it is mandatory to read this user manual and to have in depth knowledge of the information in this user manual. All actions on the controller must be carried out as described in the user manual.

This user manual is an integral part of the controller and must, as prescribed by applicable legislation, be retained for reference purposes until the controller is disposed of.

Make sure that this user manual is within reaching distance of people who come into contact with the controller. Ensure a place that is safe, dry and shielded from the sun.

If the manual is damaged, a new copy must be requested form RDA-BV..

3. Target group

This user manual is intended for users as well as installation engineers, and addresses use, maintenance and testing procedures relating to this controller and the connected drive unit. Users must be suitably trained to operate and/or test this controller in combination with the connected door, and may not perform activities on the controller under any circumstances.

4. Used symbols

The following symbols have been used in this user manual:



TIP

Gives the user suggestions or advice that make a procedure easier or more practical to execute.



COMMENT

A general comment that possibly offers extra economic benefits.



ENVIRONMENT

Guidelines that must be followed when using hazardous substances and when recycling products and materials.



CAUTION

Indicates a dangerous situation that, if safety-related instructions are not followed, could result in a minor to moderate injury and/or damage to the controller or the surroundings.



WARNING

Indicates a dangerous situation that, if safety-related instructions are not followed, **could** lead to a serious or fatal injury and/or damage to the controller or the surroundings.



DANGER

Indicates a dangerous situation that, if safety-related instructions are not followed, **will** lead to a serious or fatal injury.

Contents

Foreword	3
1. Foreword	3
2. Using the manual	3
3. Target group	3
4. Used symbols	3
Contents	5
1 Introduction	7
1.1 Intended use	7
1.2 Forbidden use	7
1.3 Life span of batteries	8
1.4 Type designation	8
1.5 Technical details	9
2 Description	10
2.1 Front view	10
2.2 Internal view	11
2.3 Description of controller	12
3 Functioning	13
3.1 Functioning	13
4 Safety	16
4.1 Safety systems	16
4.2 Safety arrangements	16
4.3 Specific safety guidelines	16
4.4 Meaning of warning signals	17
4.5 Signs and symbols	18
5 Transport and storage	19
5.1 Transporting the device	19
5.2 Storing the device for a long period	19
6 Assembly and installation	20
7 Commissioning	22
7.1 Commissioning	24
7.2 Configuring end switches (NES)	24
7.3 Configure “over-close NES position”	25
7.4 Runtime NES drive unit	25
7.5 Configuring end switches DES	26
7.6 Configure “over-close DES position”	26
8 Connection	27
8.1 Terminal connections	27
1. Mains power	27
2. Brake	27
3. Brake interruption	27
4. Potential-free contacts	28
5. Programmable input	28
6. Photocell	28
7. PNP light curtain	29
8. Pass door / Slack cable / cable breakage X12	29
9. Safety edge	29

10.	OSE light curtain.....	30
11.	External controls	30
12.	Inputs	30
13.	Fire alarm input.....	31
14.	Safety brake	31
15.	Drive unit	31
16.	Control panel	32
17.	RJ 45 connector.....	32
18.	DES / NES	32
8.2	Control cable FirePro V4	33
8.3	Operating instructions.....	34
8.4	Parameter series 0, basic settings.....	35
8.5	Parameter series 1, (end) position settings.....	37
8.6	Parameter series 2, action settings	38
8.7	Parameter series 3, emergency settings	39
8.8	Parameter series 4, warning settings	40
8.9	Parameter series 5, output settings	42
8.10	Parameter series 8, maintenance settings	44
8.11	Parameter series 9, registration	44
9	(Error) Messages	45
9.1	Status messages	45
9.2	Error messages (for questions: +31 (0) 182 23 15 25 or service@metacon-next.com)	45
10	Configuration fire/smoke detector.....	49
10.1	FD (fire detection) function (alarm/emergency)	49
10.2	Continue running if battery empty (only for digital end switch DES)	49
10.3	Maintenance counter.....	50
10.4	Smoke gasket	50
11	Signal transmitter P-cap	51
11.1	Definition.....	51
11.2	Connecting	51
11.3	Technical data:	52
12	Maintenance.....	53
12.1	Preventive maintenance	53
12.1.1	Maintenance plan	53
12.1.2	Maintenance instructions	54
12.1.3	Cleaning the device.....	54
13	Decommissioning and disposal	55
13.1	Decommissioning	55
13.2	Disposal	55
Appendices.....		56
5.	EC declaration or Declaration of incorporation.....	56
6.	Spare parts	57
7.	Installation details (to be filled in by the installation engineer).....	58
8.	Maintenance sheet	59

1 Introduction

1.1 Intended use

Safe use of this controller can only be guaranteed if it is used for its intended purpose. The manufacturer is not responsible for damage that is caused by external components or failure to comply with these instructions.

- Modifications are only permitted in consultation with the manufacturer. The manufacturer's declaration of conformity will no longer be valid if modifications are made without receiving consent from the manufacturer.
- When installing, commissioning, maintaining and inspecting the controller, the safety and accident-prevention guidelines that apply to the specific project must be respected.
- Only qualified personnel, who possess the required equipment and knowledge, are permitted to perform activities on this controller. 'Qualified personnel' can be interpreted as: people who are familiar with the installation, configuration, commissioning and operation of electric door and gate installations. They must be capable of evaluating the whole installation, recognizing potential dangers, and installing the required safety features.
- Suitable and approved tools must be used when installing, commissioning, maintaining and inspecting the controller.
- The controller must be installed in the immediate vicinity of the door that is to be operated. A good view of the door opening must be guaranteed when doing so.
- Only use safety products that comply with the applicable norms. Examples include: safety edges, photocells, smoke detectors and heat detectors.
- People who do not possess enough experience cannot use this device unless they are being supervised or have received instructions about how the device can be used in a safe manner, and understand the accompanying risks.
- Pay special attention to preventing risks that could lead to injury if people become crushed between components that are operated by the automated system and the stationary surrounding components; children must be supervised to ensure that they do not play with the equipment. The controller cannot be used for moving parts with a pass door, unless it can only be operated when the pass door is in safety mode.

If used for other purposes, please contact the supplier.

1.2 Forbidden use

The manufacturer accepts no liability for damage that has been caused by operation and connection errors, failure to comply with the user manual or sub-standard maintenance and/or service, and once again draws attention to dangerous situations that could be encountered as a result. Despite

conformity with harmonized standards, it is not possible to foresee all dangers. That is why people should only enter the danger zone if this is truly necessary. If there are doubts about the installation, do not continue and contact the supplier for clarification.

All information in this document (photos, drawings, characteristics and dimensions) may be subject to change without prior notification.

It is forbidden to connect components to the controller which have not been approved by the manufacturer.

They could:

- hinder the performance of the controller;
- endanger the safety of the user or other people;
- reduce the life span of the controller;
- nullify compliance with CE guidelines.

It is forbidden to use the controller for a purpose other than the intended use. Failure to comply with the intended use could endanger the safety of the user or other people.

1.3 Life span of batteries

The life span of batteries used in this controller is ca. 2 years if installed in an environment of ca. 20°C. Environment temperatures above 40°C or below 5°C during use or above 40°C or below -15°C during storage can have an impact on the life span and/or correct operation of the batteries. We recommend replacing the batteries every year.

1.4 Type designation

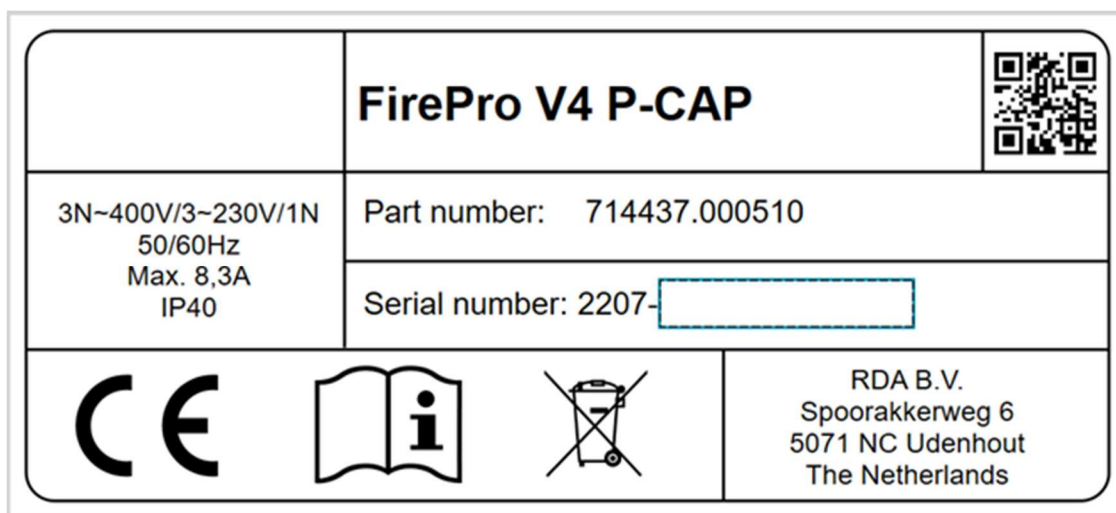

Figure 1 Example of the type plate

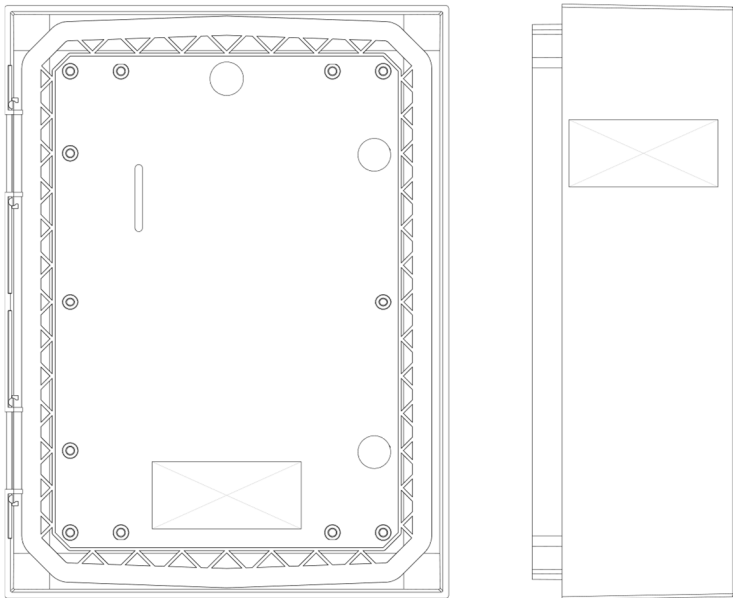

Figure 2 Position of the type plate

1.5 Technical details

Table1 Technical details

Data	Explanation
Weight	10 kg
Height	400 mm
Width	300 mm
Depth	150 mm
Electricity consumption	Max. 2.2 kW
Power	3N~400Vac +/- 10%, 50/60 Hz 3~230Vac +/- 10%, 50/60 Hz 1N~230Vac +/-10%, 50/60 Hz
Fuse	Max. 6.3 A slow
Motor capacity	Max. 2.2 kW
Electricity	Max. 8,3 A
Brake	24 Vdc
Control voltage	24 Vdc
Control current	300 mA
External power	24 Vdc
Current external power	Max 500 mA
Relay outputs	potential-free changeover switches
Load of relay contacts	Max. Ohm load = 1 A / Max. inductive load = 1 A
Battery	Voltage : 12 Vdc Capacity : 5.2 Ah LxWxH : 90 x70 x 106 mm Brand : CSB battery Type : HR1221W Weight : 1.8 Kg Technology : AGM
Protection class	IP 40
Environment temperature	+5...+40°C
Relative humidity	Max. 93% (non-condensing)
Vibration	Install vibration-free (e.g. brick wall)

2 Description

2.1 Front view

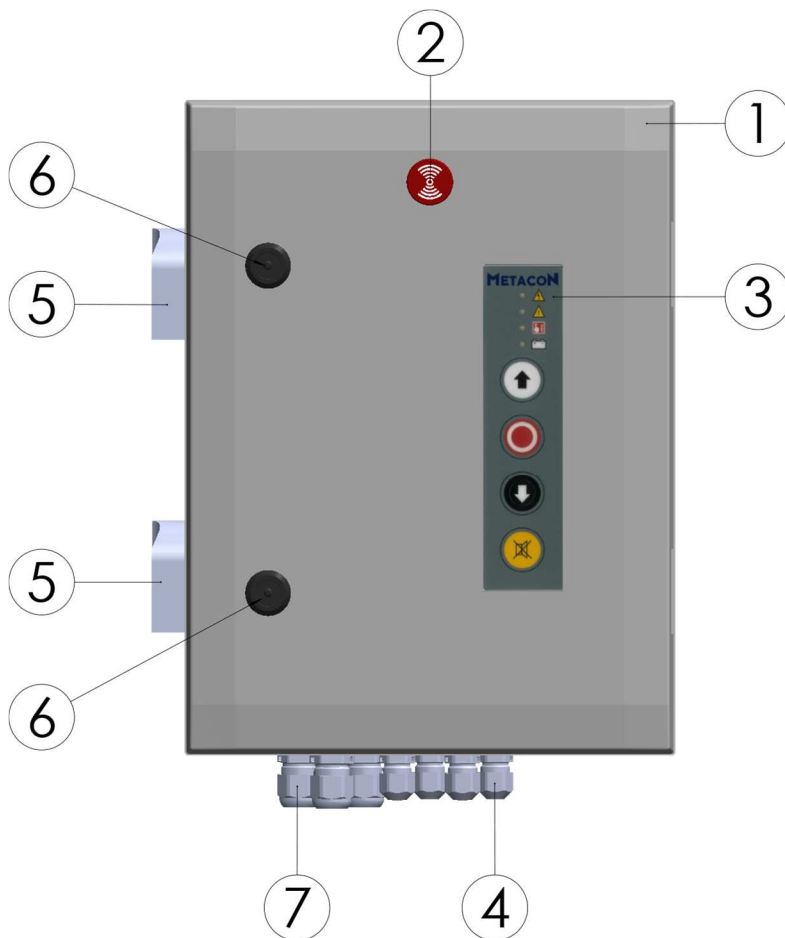

Figure 3 Front view

Table 2 Layout front view

No.	Component
1	Casing
2	Signal transmitter
3	Front panel
4	Cable inlet 4 x M16
5	Ventilation
6	Lock
7	Cable inlet 2 x M20

2.2 Internal view

The FirePro includes a cabinet containing a control circuit board in combination with power/charger and 2 batteries (12V-5.2Ah). The lid of the cabinet has a control panel that features 4 status LEDs.

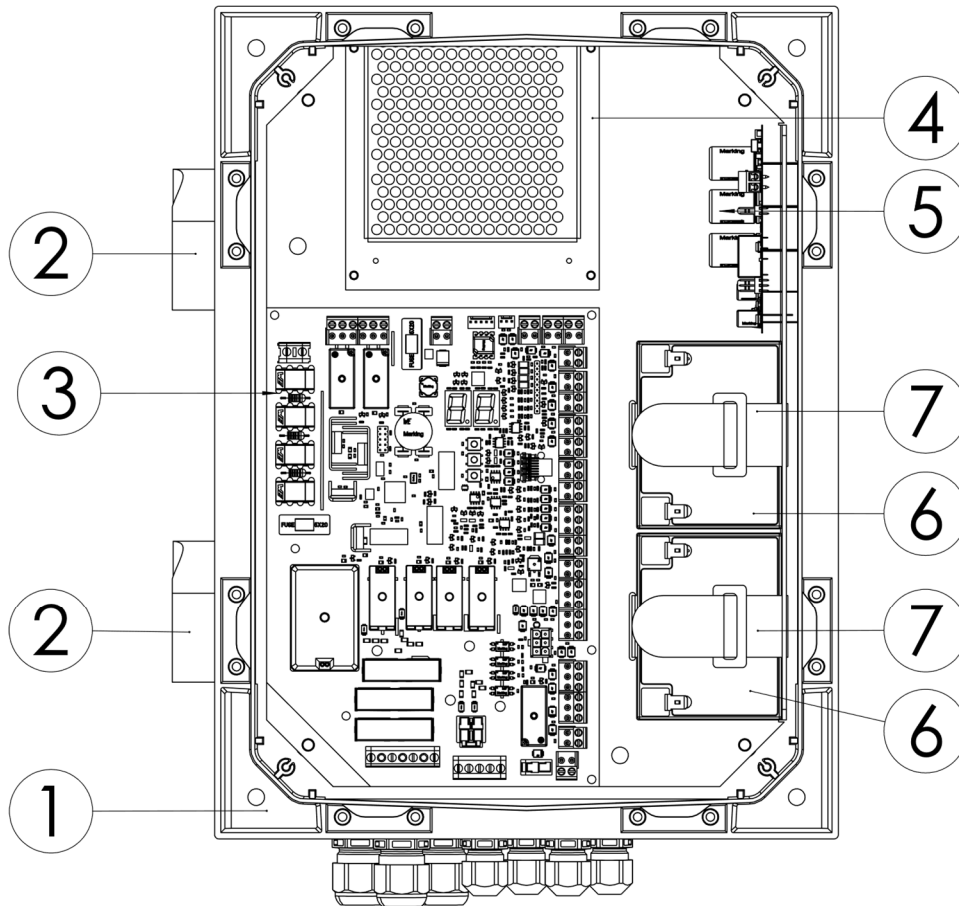

Figure 4 Internal view

Table 3 Layout internal view

No.	Component
1	Casing
2	Ventilation
3	FirePro V4 control circuit board
4	Power/charger
5	Signal transmitter board (P-CAP)
6	Battery
7	Battery attachment



WARNING

Only use accessories that comply with the applicable standards.

2.3 Description of controller

The FirePro is a controller for vertically-operating fire and/or smoke-proof doors (for example, shutter sectional doors and fire hatches) that feature a FailSafe drive unit (FS series) by GfA-Elektromaten.

This controller is part of an electrically-powered fireproof door, and uses its own energy - in this case, based on gravity - to close the door in the event of a fire.

The FirePro includes a cabinet containing a control circuit board in combination with power/charger and 2 batteries (12V-5Ah).

Characteristics of this controller:

- Hold to run or automatic operation
- Operation via panel on cabinet lid or external controls
- Status display via 4 LEDs on cabinet lid
- Buzzer with mute function
- Fire alarm input
- Smoke and heat alarm input
- Input for safety edge
- Input for security contacts (safety brake, pass door/slack cable contact)
- Input for sensor operation
- Input for escape button
- 2 potential-free programmable switch contacts
- Output for signal transmitter

In case of fire alarm, loss of power or empty batteries, the door will lower because power to the electric brake is cut (if this has been selected in the menu). If mains power is still present, the door will lower until the 'close' end switch or the "over close" end switch has been reached. Once the fire alarm returns to normal, the door will be released immediately (par.5.3), after a certain period of time (par.3.4) or can be reset (par.4.6).

3 Functioning

3.1 Functioning

The FirePro covers a cabinet with a control circuit board in combination with a power supply/charger.

This controller can operate as “hold to run” as well as automatically when in normal mode.

- Operation in normal mode is possible using the buttons on the cabinet and/or the external up, stop and down controls. An input is also available for sensor-based operation (e.g. pull switch).
- The lid features 4 LEDs for showing the status of the controller (see table 7).
- An input is available for the safety contact (NC) and safety brake; this input is a stop function. There is also an input for cable breakage protection and/or a pass door contact; this is an NC contact in series with a 5.1kΩ +/-10% resistor. The controller can be attached to batteries so that the control will continue to operate effectively in case of power failure, until the batteries are almost empty.

WARNING



Upon delivery, the + side of the batteries will be disconnected in order to prevent drainage! Make sure that the batteries never become completely empty; this can be caused if the controller is not connected to mains power for a long period of time. The batteries cannot be re-used if they become completely empty. In this case, replace the batteries. Disconnect the battery connection if the door is in a safe position.

WARNING



If the drive unit has mechanical limit switches, an interim stop is only possible if the “over-close” function is not being used.

- In case of fire alarm, the ‘close in case of power loss’ option or empty batteries, the door will lower because power to the electric brake will be cut. If power is still present, the door will lower until the ‘close’ end switch or the “over close” end switch has been reached.

PLEASE NOTE: in case of digital end switches (DES), there must be effective communication between the end switch and the controller!

WARNING



The doors will close automatically if the fire contact is activated, in case of power failure or if the batteries are almost empty (and the “close” option has been selected in this case). PLEASE NOTE: this movement can be performed without the safety feature!

- The menu can be used to configure whether the door, if closing for safety reasons, will lower until the normal end switch or until the “over-close” end switch has been reached. The “over-close” end switch makes it possible to close the door further than it would close during normal operation. It is also possible to make an interim stop, for a configured time, when closing in case of a fire, in case of power failure or in case of low battery voltage.

- In case of a fire alarm, the door will be released immediately or after an extended period of time.
- There are two fire alarm inputs. The menu can be used to decide whether or not they must be reset so that the door is restored to normal operating mode. If a fire alarm input must be reset, a time delay can be selected for releasing the door. This means the door will only operate normally after the configured period of time.
- It is also possible to select whether escape is possible or not when the door is completely closed at a desired fire alarm input. A decision can also be made about whether the contact, which indicates that the door is closed, will be switched on if the door has closed after the fire alarm input was activated.



WARNING

Once a fire alarm has been activated, escape will no longer be possible if the door is fully closed. That is why, in accordance with existing legislation, a separate escape route must be available.

- There are two inputs that can be configured via the menu. These inputs have various functions, as described in the menu-related explanation in this user manual.
- A P-CAP signal transmitter is installed in the casing. This will issue a signal if an error message becomes active. If the “mute” button is pressed on the lid, this will be stopped until a new message becomes active. The “mute” button will not work if the door closes during emergencies.
- An output is present for connecting an extra signal transmitter.
- It is possible to connect a safety edge. This can be done using a safety feature with potential-free relay contact (N.C.) in combination with a 1.2K Ω resistor that features an air pressure switch/dw contact. Or via an electric pressure frame with an 8.2K Ω resistor or opto sensors.



WARNING

If a safety edge is used, the door must be inspected to confirm that it complies with applicable standards. If a safety feature with a relay contact (potential-free NC contact) is used, a 1.2K Ω resistor must be connected in series within this safety feature. In this case, a test must also be carried out on the DW/air pressure switch.

- During normal operation, the safety edge will only work if self-hold closing has been selected. During closure in case of fire alarm, low battery voltage or power failure (if batteries are present and have enough capacity), the software can be used to switch the safety edge on or off as preferred. If the safety edge has been activated, the door will stop descending when the safety edge is triggered. The programming menu can be used to select the preferred safety feature, and it is possible to configure the time that the door will wait (when a safety feature is triggered) before continuing to descend. If mains power is still present, one can also decide to open the door completely and then close once again. In this case, the door will stop and fully open again. The same can be done when activating the photocell safety feature.



WARNING

If the safety edge or photocell safety feature is activated in case of closure during a fire alarm, power failure or almost empty battery, the controller will regard the concerned safety feature to be faulty if it is activated continuously for 120 seconds (factory setting) or longer, and the door will then continue closing without the safety feature!

- It is possible to connect an escape button, whereby the door can be opened in case of a fire alarm (if mains power is still present), to allow someone to escape. The door will close again after a configured time. There is also a setting that allows the door to be opened again with the open button if mains power is available. The door will close again when the button is released.
- Parameter 8.5 in the menu can be used to activate a maintenance cycle. The LED will flash red and green alternately if this has been activated and the number of configured cycles has been reached. A message will appear on the display. Parameter 8.7 can also be used to close the door once the number of configured movements has been reached.

4 Safety

4.1 Safety systems

Only use safety products that comply with the applicable norms.

Examples include: safety edges, photocells, smoke detectors and heat detectors.

4.2 Safety arrangements

Only qualified personnel, who possess the required equipment and knowledge, are permitted to perform activities on this controller. 'Qualified personnel' can be interpreted as: people who are familiar with the installation, configuration, commissioning and operation of electric door and gate installations. They must be capable of evaluating the whole installation, recognizing potential dangers, and installing the required safety features.

This controller is a component within a machine. Make sure that every component used in the installation is suitable for the intended system as a whole.

Do not continue with the installation if one of the components is not suitable!

Perform a risk analysis, which includes a list of essential safety guidelines as prescribed in Appendix I of the Machinery Directive, where the implemented solutions are mentioned. The risk analysis is one of the documents that is included in the technical dossier of the electrically powered door. This must be compiled by a professional installation engineer.

4.3 Specific safety guidelines

Safe use of this controller can only be guaranteed if it is used for its intended purpose. The manufacturer is not responsible for damage that is caused by external components or failure to comply with these instructions.

Modifications are only permitted in consultation with the manufacturer. The manufacturer's declaration of conformity will no longer be valid if modifications are made without receiving consent from the manufacturer.

When installing, commissioning, maintaining and inspecting the controller, safety and accident-prevention guidelines that apply to the specific project must be taken into consideration.

Suitable and approved tools must be used when installing, commissioning, maintaining and inspecting the controller. Before starting activities on this controller, the door must be placed in a safe position, the mains power must be cut and the poles of the batteries must be disconnected.



WARNING

Performing activities on the controller while it is still being powered is perilous and can cause serious injury!



WARNING

Only use the controller for the purpose for which it was designed. See 1.1 Intended use on page 7.



WARNING

The controller can only be managed by people who have read the user manual and are thus sufficiently familiar with the functioning, operation, maintenance, etc. of the controller, as described in this user manual.



DANGER

It is forbidden to remove, bypass or deactivate safety features and protective devices.



CAUTION

Make sure that all safety features are correctly activated again after all maintenance activities and other interventions.



ENVIRONMENT

Comply with local legal requirements for all products that are used in the controller and for all products used to maintain and clean the controller.

4.4 Meaning of warning signals

Table 4 Warning signals control panel























No.	Warning signal	Symbol	Meaning
1	Green LED 		LED on: Mains power present LED flashing: Maintenance cycle reached
1	Red LED 		LED on: Error message active
2	Red LED 		LED on: Emergency active
3	Red LED 		LED on: Battery error
4	Mute button		Switch off buzzer
5	Signal transmitter		See Parameter 5.5

Table 5 Warning signals power/charger.

No.	Warning signal	Symbol	Meaning
1	Mains fail		LED on: No mains power
1	Batt Low		LED on: Low battery voltage
2	Batt O/C		LED on: No battery present
3	Charger loss		LED on: Error message charger
4	Batt O/C + Batt. low		LED on: High impedance batteries (replace batteries)
5	Status		LED flashing: charger OK

4.5 Signs and symbols

Table 6 Signs and symbols

Pictogram	Explanation
	Please carefully read the manual before using this device.
	Risk of electrocution Low voltage – 230/400 V ac
	Warning Possible injury or danger
	Emergency
	Battery
	Switch off buzzer
	Factory setting



CAUTION

Make sure that the pictograms are visible at all times. Clean the pictograms on a regular basis and replace them in case of wear and tear.

5 Transport and storage

5.1 Transporting the device

The device will be delivered by specialized companies and will be assembled and configured by an authorized installation engineer. As the operator, you are responsible for monitoring requirements at the configuration location.

5.2 Storing the device for a long period

Environment temperatures above 40°C or below 5°C during use or above 40°C or below -15°C during storage can have an impact on the life span and/or correct operation of the batteries.

Upon delivery, the + side of the batteries will be disconnected in order to prevent drainage!

Disconnect the battery if the controller is not being used; this will help to prevent deep discharge.

6 Assembly and installation

The following points must be inspected and checked to make sure that the controller is assembled in a proper and professional manner:

- Assembly of the controller must only take place indoors on a dry, vibration-free and flat surface.
Make sure that the maximum permissible load of walls and attachments has not been exceeded.
- Any unused cable glands must be sealed in order to comply with the required IP value.
- Wires must have the following properties:
 - Flame retardant in accordance with IEC 60332-1-2
 - Prevent spread of flames in accordance with IEC 60332-3-22, IEC 60332-3-24/IEC 60332-3-25
 - Halogen-free in accordance with IEC 60754-1
 - Corrosivity combustion gases in accordance with IEC 60754-2
 - Low smoke density in accordance with IEC 61034-2
- The phase(s) in the power supply (3N~400Vac/3~230Vac/1N~230Vac-50Hz, +/-10%) must be protected against short circuit and overload via a suitable fuse or 16A circuit breaker type B.
- The following applies if the power cable has a 5-pin 16A CEE plug (3 phases, neutral & ground) or a 3-pin 16A CEE plug (1 phase, neutral & earth): install the 16A power socket in a clearly visible and accessible location (so that power can be cut in case of emergencies) in the immediate vicinity of the controller and cut off the power in accordance with applicable standards/guidelines. Once the controller and the power cable with power socket have been installed, make sure that all screws have been properly tightened and that everything has been connected correctly.
- The installation engineer must compile a risk analysis for the whole installation. In this case, make sure the door in question is properly secured because there is a risk of people and objects being crushed.
- The installation must at least comply with all European and legal legislation and standards.
- Safety switches, mechanical stops or other safety systems must be used to prevent the door from overshooting the furthest setting.
- The technical details of any implemented external components, such as e.g. photo cells, must be checked. They must not cause the maximum permissible load of the controller to be exceeded.
- Firmly tighten the cable glands so that the strain placed on the inserted cable is reduced.
- Make sure that the mains power cable is not damaged. If this is damaged, replace it with an original cable from the manufacturer.
- An inspection must be carried out by the designated installation engineer when commissioning the system.
 - The following must be done during this inspection:
 - A list must be filled in for approved and connected components.
 - Documents that accompany all the components must be stored together with this manual.
 - The interaction between all components must be tested by simulating a fire or by activating the test input (if configured in the menu).
 - A test must be carried out to check if the system allows the door to close in the event of component malfunctions (for example, by removing a detector, cutting the power or other such actions).
 - Finally, check if all components have been installed as described in the accompanying manual.

The installation engineer must hand over a fully completed and signed inspection report to the end user.

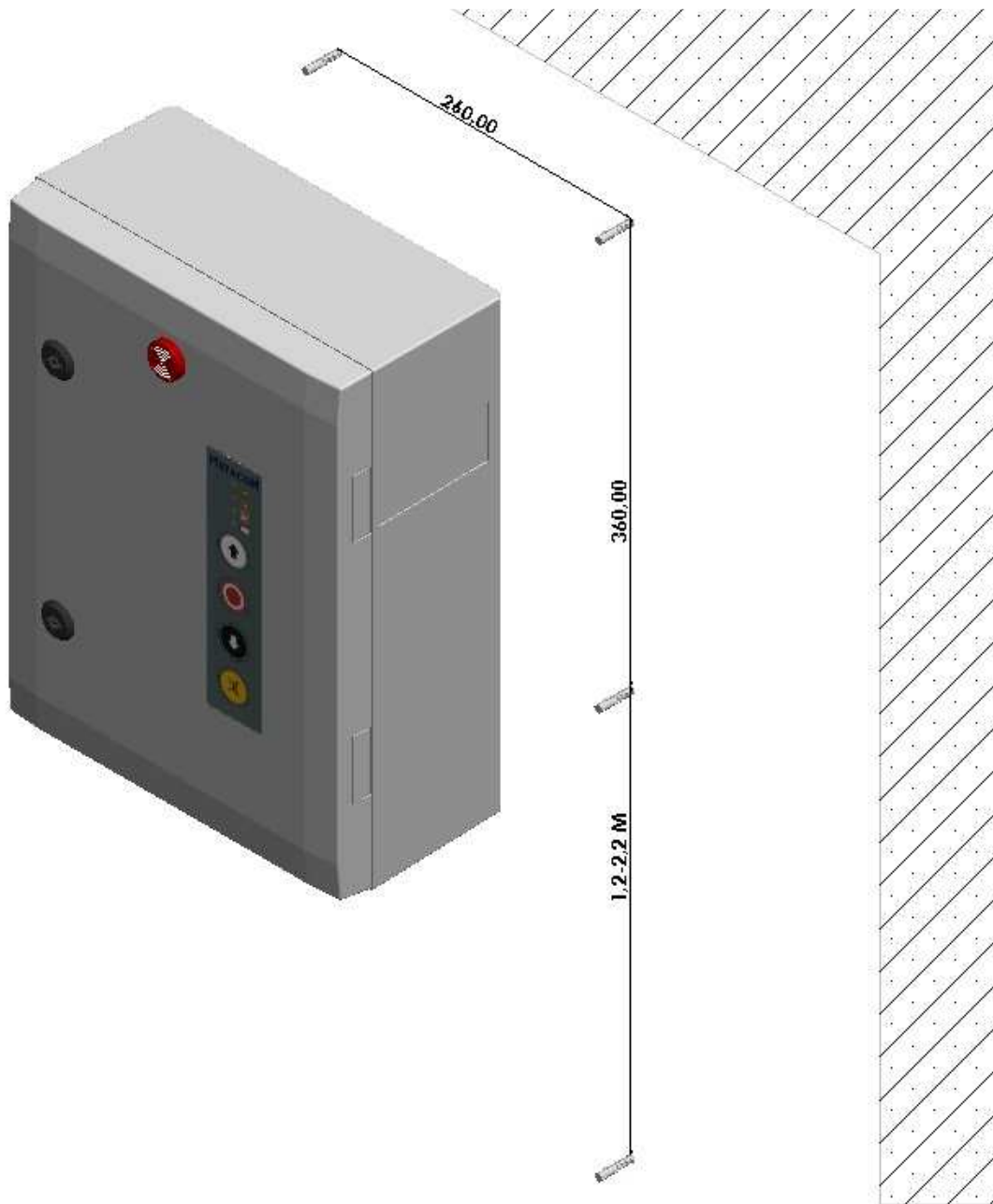

Figure 5 Assembly instructions

7 Commissioning

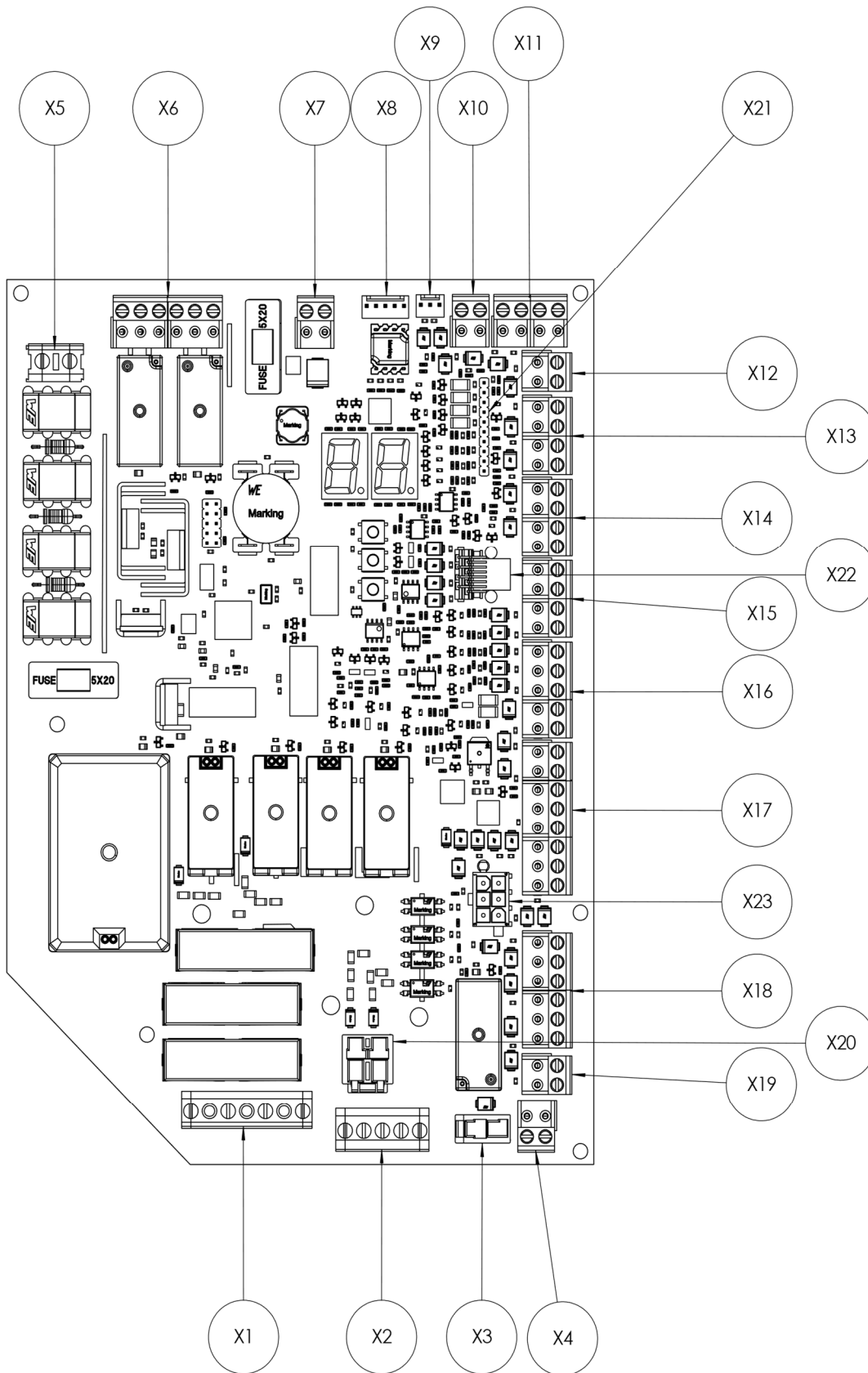

Figure 6 Circuit board FirePro V4

Table 7 Terminal numbering

Terminal number	Description	Connect
X1	Mains power	L1, L2, L3, N
X2	Ground	PE
X3	Brake	+ = 4 - = 5
X4	Brake interruption	1 = Com 2 = Nc
X5	Voltage to power supply	L1 = 230 Vac N = neutral
X6	2 potential-free programmable contacts Output 1 (par. 5.1) = Terminal 1+2+3 Output 2 (par. 5.2) = Terminal 4+5+6	1 + 4 = Com 2 + 5 = Nc 3 + 6 = No
X7	24 Vdc input for power supply	1 = 24 Vdc 2 = GND
X8	Status battery charger	
X9	Connection P-CAP	1 = + 24 Vdc 2 = GND 3 = Light / Siren
X10	Programmable input (potential-free NO contact)	1 = Com 2 = No
X11	Photocell	1 = + 24 Vdc 2 = GND 3 = Com 4 = No
X12	Pass door / slack cable /cable breakage (resistor or NC contact)	1 = Com 12 Vdc 2 = NC (5k)
X13	Safety edge	1 = + 12 Vdc (Max. 50 Ma) 2 = Resistor (1K2 / 8K2) 3 = Opto 4 = GND
X14	Transmitter LIGI 07 OSE light curtain	1 = + 24 Vdc (Brown) 2 = GND (Blue) 3 = Alignment input (Black) 4 = Synchronization (White)
X15	Receiver LIGI 07 OSE light curtain	1 = + 24 Vdc (Brown) 2 = GND (Blue) 3 = OSE output (Black) 4 = Synchronization (White)
X16	External controls	1 = Common 2 = Stop 3 = Open 4 = Close 5 = Mute
X17	Inputs	1-2 = Sensor (SBS) 3-4 = Escape button 5 = + smoke detectors (4K7) 6 = - smoke detectors (4K7) 7 = 24 Vdc 8 = GND
X18	Fire alarm input 2	1-2 = Fire alarm (8K2) 3-4 = Reset fire alarm 5 = 24 Vdc 6 = GND
X19	Safety brake / Safety features	1 = Com 2 = NC
X20	Drive unit	
X21	Control panel lid	
X22	RJ 45 connector	
X23	DES / NES	

7.1 Commissioning

The end switches of the drive unit must first be connected before power is switched on for the first time. The controller will then automatically recognize the used end switches when switched on, and the controller will configure accordingly. It is not possible to move the door if the controller is not configured correctly. If this is the case, the controller can be easily modified or reset.

The controller can only be configured effectively via the menu once the end positions have been set.

7.2 Configuring end switches (NES)

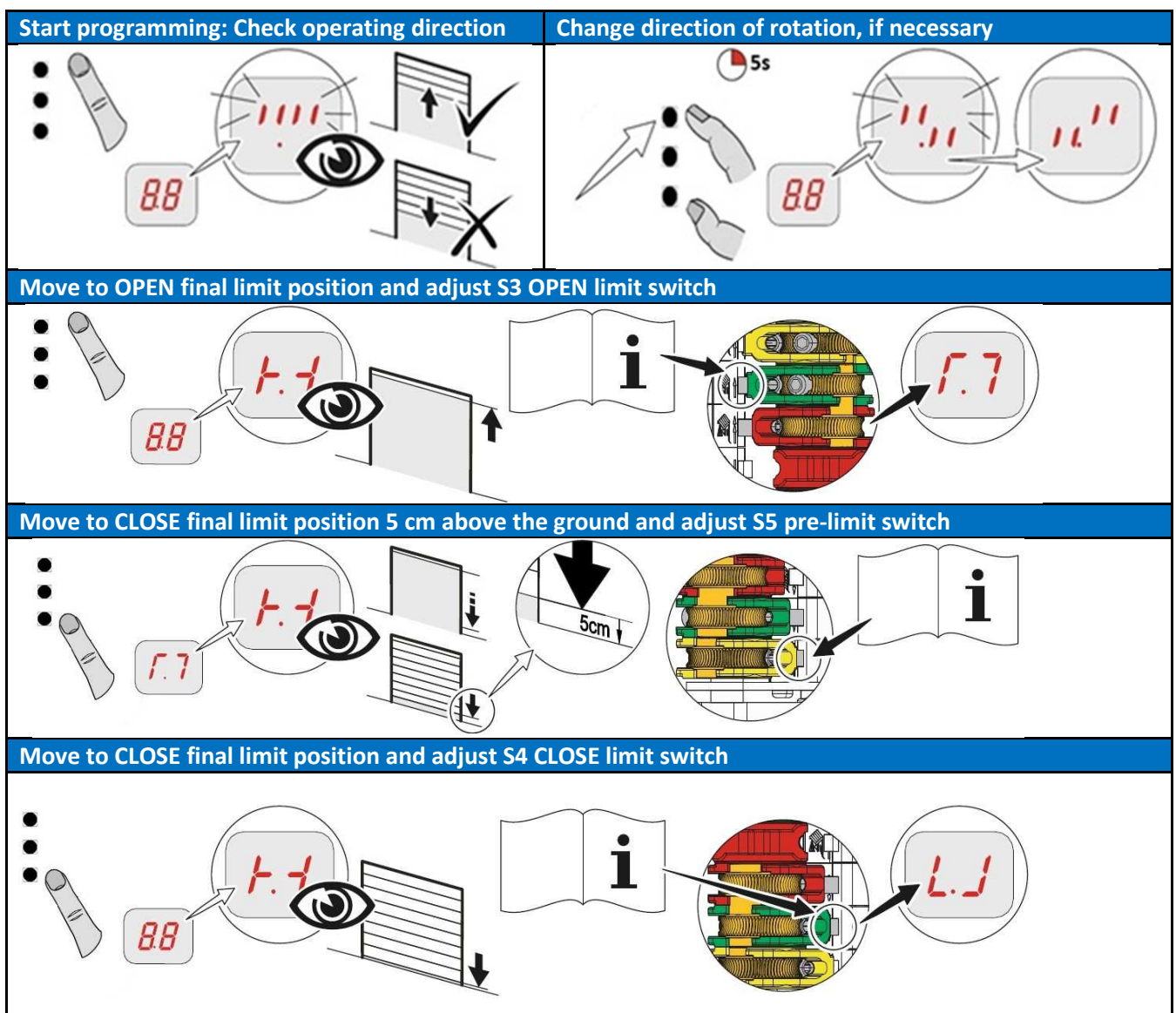

Table 8 Configuring end switches (NES)

7.3 Configure “over-close NES position”

If necessary, configure the extra end switch S6 as selected in the menu (how the switch will be used in case of fire). End switch S6 can be used in 3 ways:

- As “over-close” end switch, so that the door runs further than normal in case of fire alarm, smoke alarm or lack of battery power; or
- As half-opening in case of fire alarm, smoke alarm, loss of power or low battery voltage (parameter 2.1), or as intermediate stop (parameters 4.1 and 4.2).
- As intermediate position switch if opting for half-open in case of fire alarm (parameter 4.3).

Configure this end switch at the position where the door must stop in case of fire alarm, smoke alarm, loss of power or almost empty battery, if the option has been selected (in the menu) to lower the door until this position.

7.4 Runtime NES drive unit

Make sure that the runtime for drive units with cams/mechanical end switches (parameter 2.1) is not too short. Make sure that it is longer than the time that the door needs to go from a fully closed to a fully open position. The door will stop moving if the drive unit requires more than the configured time.

7.5 Configuring end switches DES

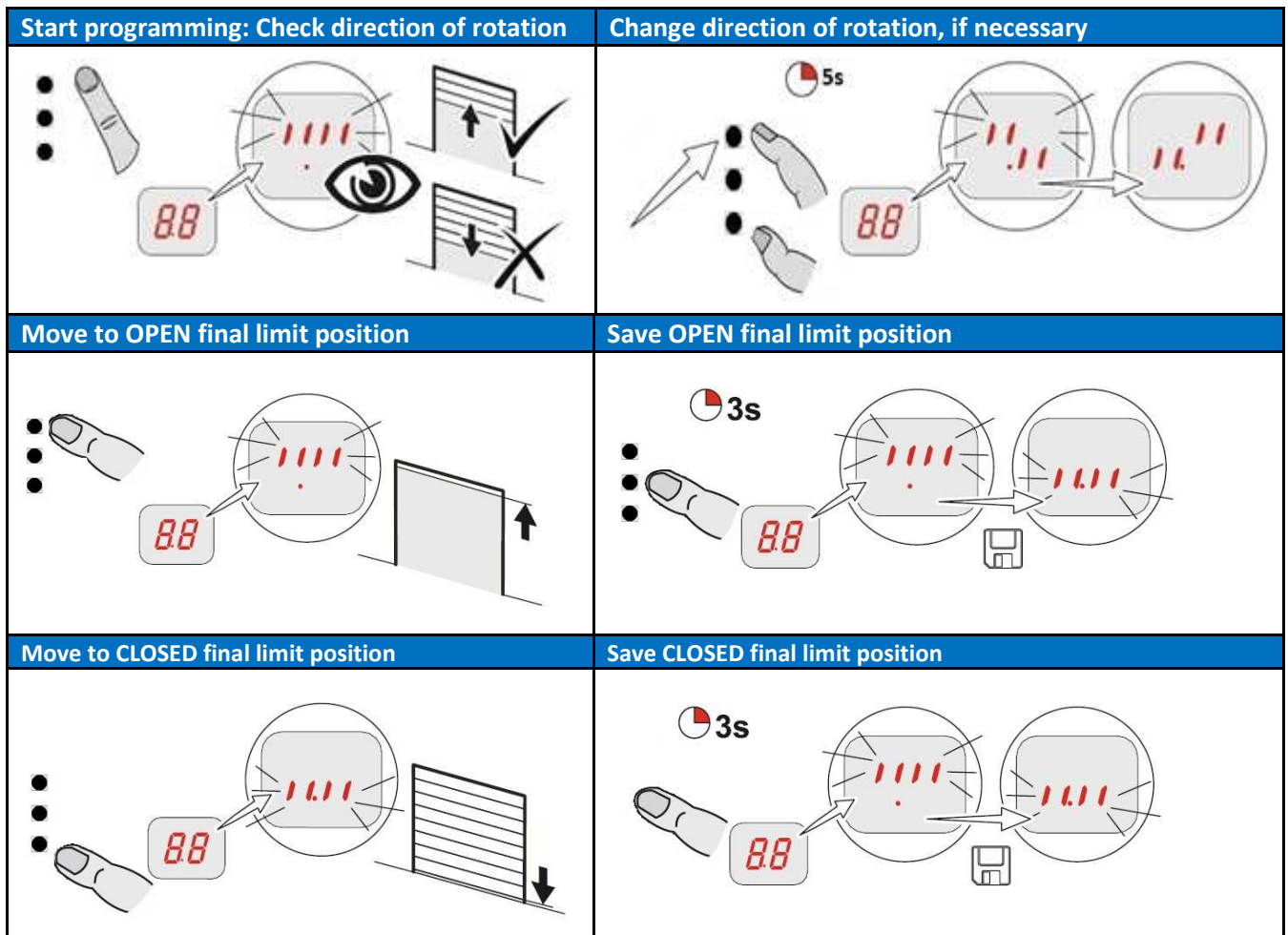

Once the end position has been set, the status of the door will be shown on the display using the symbols below.

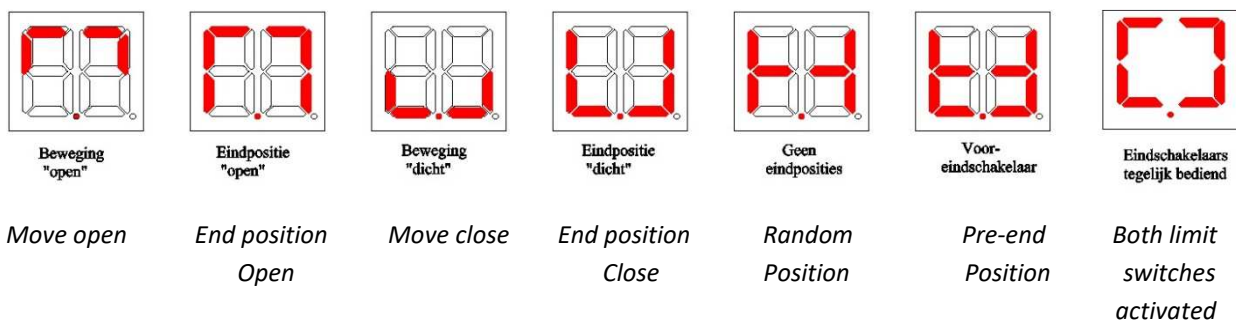

Figure 7 status symbols

7.6 Configure “over-close DES position”

The “Over-close” position is set (as standard) at the same position as the saved ‘end position closed’. Use parameter 1.7 to configure this position at the position where the door must stop in case of fire alarm, smoke alarm, loss of power or almost empty battery, if the option has been selected (in the menu) to lower the door until this position.

8 Connection

8.1 Terminal connections

1. Mains power

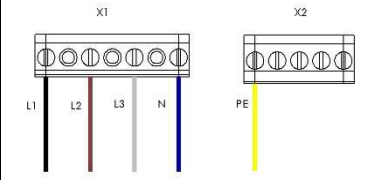
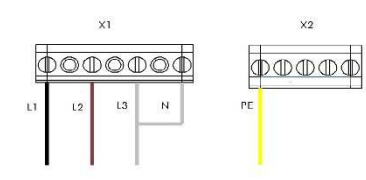
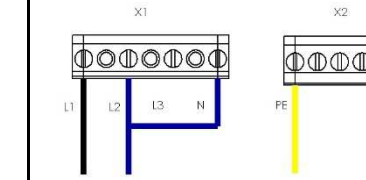
Mains power X1 + ground X2			
			
3N~400Vac	3~230Vac	1~230Vac	

2. Brake

Brake X3	Connect
	<p>The 2-pin connector for the FirePro motor cable is connected to X3. This is used to operate the brake.</p> <p>When removing wires on the motor side, make sure that the + (terminal 11) and – (terminal 12) are connected correctly (brake will not disengage properly if connected incorrectly).</p>

3. Brake interruption

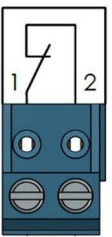
Brake interruption X4	Connect
	<p>A switch can be connected to X4 in order to cut the 24 VDC supply voltage to the brake. In emergencies, this switch can be used (without accessing the software) to close the door in case of an accident. This will also cause the signal transmitters to be activated.</p> <p>Please note: the door can still be opened but will close immediately because the brake has been disconnected.</p> <p>The switch must be able to control an inductive load of 1.1A/24VDC!</p> <p>If this input is not used, connections 1 and 2 of X4 must be interconnected using a wire bridge.</p>

4. Potential-free contacts

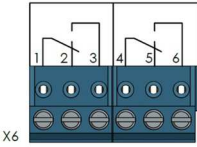
Potential-free contacts X6	Connect
	<p>X6 features two outputs as potential-free changeover switches. They can be configured for various functions via parameters 5.1 and 5.2.</p>

5. Programmable input

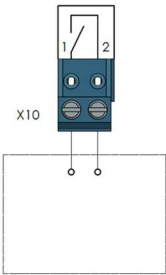
Programmable input X10	Connect
	<p>This input can be programmed using parameter 2.6</p>

6. Photocell

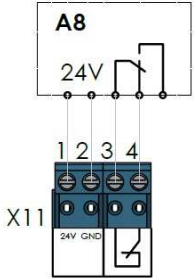
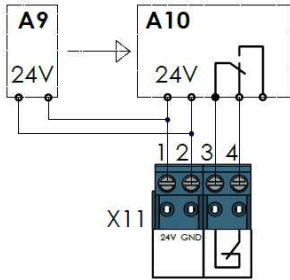
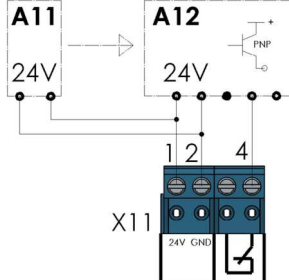
Photocell X11		
		
A 8 reflection photocell	Through-beam photocell A9 = Transmitter A10 = Receiver	Through-beam photocell A11 = Transmitter A12 = Receiver



WARNING

In case of fire, the door will remain open for max. 120 sec. If the safety feature is still activated, the door will close without the safety feature.

7. PNP light curtain

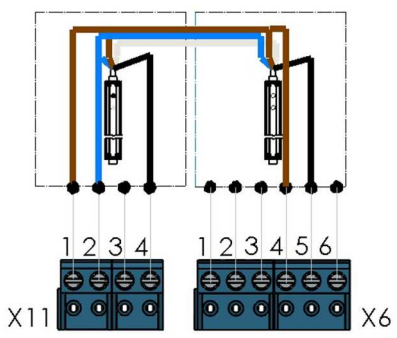
LIGI 01 PNP light curtain X11	Description
	<p>Transmitter X11-1 = Brown X11-2 = Blue X6-4 = 24 vdc X6-5 = Black</p> <p>Recipient X11-1 = Brown X11-2 = Blue X11-4 = Black</p> <p>Connect both white wires to each other</p>

8. Pass door / Slack cable / cable breakage X12

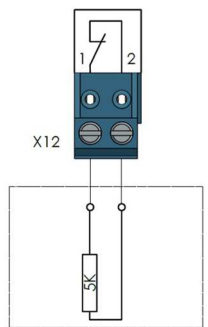
Pass door / Slack cable / cable breakage X12	Connect
	<p>X12 is an input that features a stop function. This input can be used to connect the contact for the pass door and the slack cable switch. This is connected in series as an N.C. contact with a 5.1KΩ resistor. If there are several normally closed contacts, they must be placed in series and a 5.1KΩ resistor must be placed on the last contact so that a short-circuit in the connecting cables will not have an impact on this input. If this input is not used, a 5.1KΩ resistor must be placed between connection 1 and 2.</p>

9. Safety edge

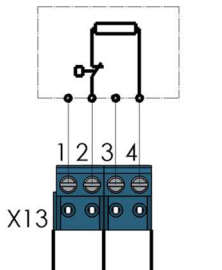
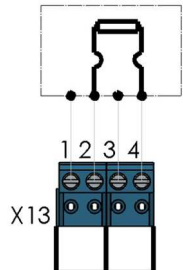
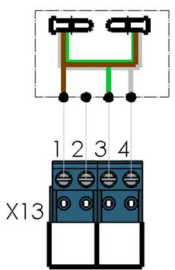
Safety edge X13		
		
Pneumatic safety edge (1K2)	Electric safety edge (8K2)	Optical safety edge



WARNING

In case of fire, the door will remain open for max. 120 sec. If the safety feature is still activated, the door will close without the safety feature.

10. OSE light curtain

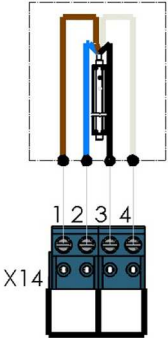
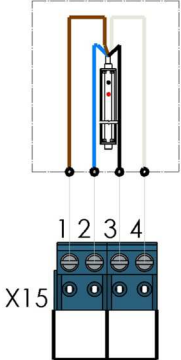
Transmitter LIGI 07 OSE light curtain X14	Receiver LIGI 07 OSE light curtain X15	Description
		<p>1 = Brown 2 = Blue 3 = Black 4 = White</p>

11. External controls

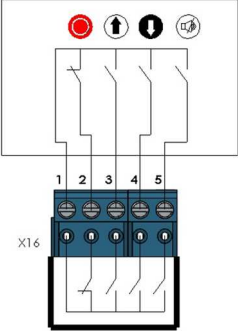
External controls X16	Connect
	<p>Connect</p> <p>X16 can be used to connect external UP-STOP-DOWN controls.</p> <p>If X16 is not used, connect terminals 1 and 2 (stop function) using a wire bridge.</p> <p>There is also an input for an external “mute” button.</p>

12. Inputs

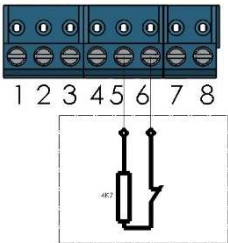
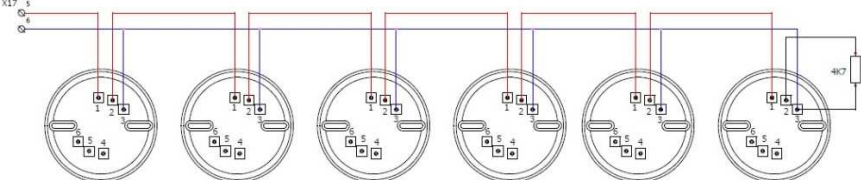
Inputs X17	Connect
	<p>Inputs for Sensor, escape button and fire/smoke alarm with detectors for potential difference (short-circuit detection via resistor 4K7).</p> <p>X17.7 (+) and X17.8 (-) feature a 24VDC connection. This can be used as power supply for external components.</p> 

13. Fire alarm input

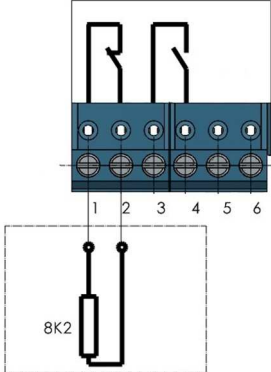
FDC Fire alarm input X18	Connect
	<p>Fire alarm input 2 can be connected as potential-free N.C. (break) contact in series with an 8.2kΩ resistor or as a potential-free N.C. contact. This choice can be made in the menu for parameter 5.7.</p> <p>This also features an input for resetting the fire alarm. This normally does not need to be reset. Parameter 4.6. offers the option of resetting one or both fire alarms in order to return to normal operation. This can be done by connecting a push button at X18.3 and X18.4 as potential-free normally open contact (N.O. contact).</p>

14. Safety brake

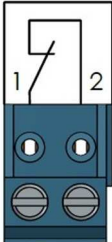
Safety brake X19	Connect
	<p>X19 is an input that features a stop function. This input can be used to connect the contact for the safety brake. This is connected as an N.C. contact. If this input is not used, a wire bridge must be placed between connection 1 and 2.</p>

15. Drive unit

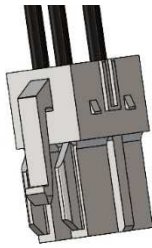
Drive unit X20	Connect
	<p>The 4-pin connector for the FirePro motor cable is connected to X20. This is where the phases (U, V, W) are mounted.</p>

16. Control panel

Control panel lid X21	Connect
 The image shows a vertical control panel lid with the brand name 'METACON' at the top. Below the name are several indicators: two yellow triangles with exclamation marks, a red square with a white 'X', a white square with a black 'X', a white circle with a black upward arrow, a red circle with a white center, a white circle with a black downward arrow, and a yellow circle with a black 'X'.	<p>The control panel is connected to connector X21 using a flat cable.</p>

17. RJ 45 connector

RJ 45 Connector X22	Connect
 The image shows a black RJ 45 connector with a standard RJ 45 port and a small circular button on the side.	<p>RJ 45 connector for connecting a future expansion of the RDA Updater.</p>

18. DES / NES

DES / NES X23	Connect
 The image shows a grey 6-pin connector with four black pins protruding from the top and a latch on the side.	<p>The end switches of the drive unit are connected to X23 using the 6-pin connector of the FirePro motor cable.</p>

8.2 Control cable FirePro V4

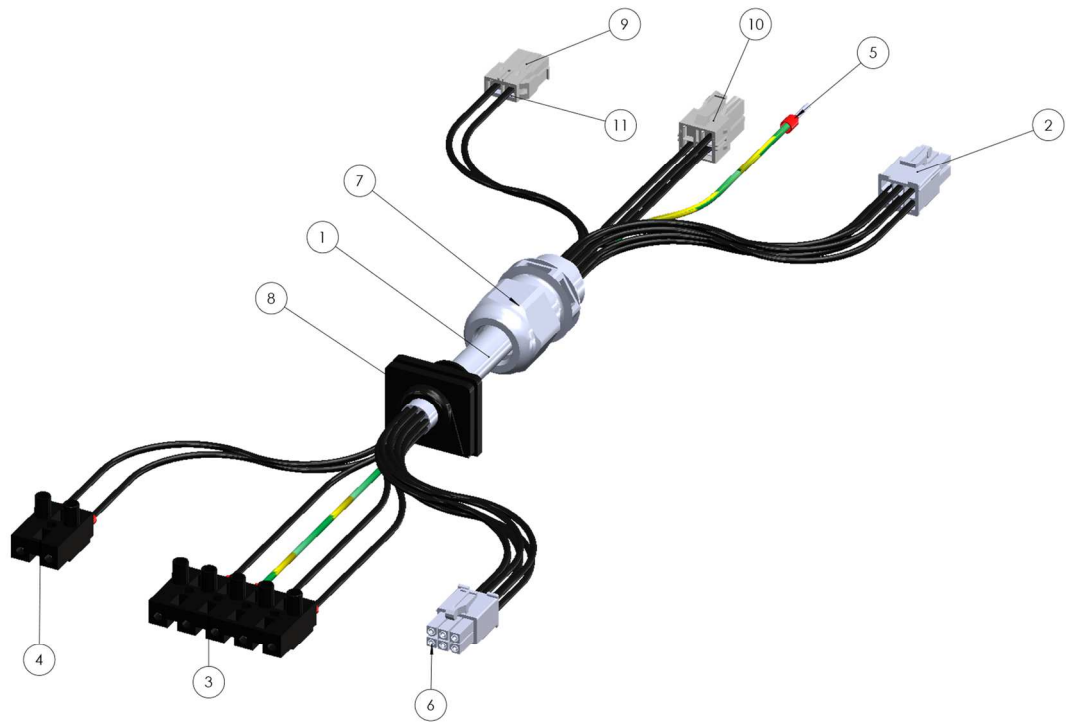

Figure 8 FirePro V4 Control cable

Table 5 Components Control cable FirePro V4

Number	Description
1	Cable
2	DES / NES connector
3	Phase connector drive unit
4	Brake connector drive unit
5	Wire-end ferrule
6	DES /NES pin for connector
7	Cable gland
8	Cable inlet rubber
9	Brake connector circuit
10	Motor connector circuit
11	Pin for motor and brake connectors

8.3 Operating instructions

The circuit board features 3 push buttons under the display, namely: "v", "^" and "stop/ok" (see image). When in normal operation, these buttons work as up-stop-down controls. A password must first be entered before the menu can be accessed (the default is 99; can be modified in menu 9.6). Once the password has been entered, the menu will remain accessible for 10 minutes without requiring a password.

The menu can be opened/closed by pressing and holding the "stop/ok" button until the display shows 0 (after about 3 sec) then with the "v" and "^" buttons the first digit of the password can be entered (default is 9) And this can be confirmed with "stop/ok". Then the display moves to the second digit and it can be selected with the "v" and "^" buttons this can also be confirmed with the "stop/ok" button. If the password is correct the display shows 0.0. If the password is incorrect or the stop button on the cover is pressed, the menu is exited.

Start programming	Select and confirm program point
Set and save functions	Exit programming
Move to OPEN final limit position	Save OPEN final limit position
Move to CLOSED final limit position	Save CLOSED final limit position

8.4 Parameter series 0, basic settings

Parameter	Description	Settings	
0.0	Exit menu	Exit the menu by pressing "stop/ok"	
0.1	Operation mode	.1) "Hold to run" open & close	X
		.2) Automatic open, "hold to run" close	
		.3) Automatic open & close "hold to run" close possible with external controls	
		.4) Automatic open & close "hold to run" close not possible with external controls	
		.5) Automatic open & close "hold to run" close with lid and external controls not possible if the safety edge and/or photocell is/are activated (only possible using push button on circuit board)	
0.2	Safety edge	.1) Automatically detect safety edge	X
		.2) Opto sensors	
		.3) 1.2kΩ DW/air pressure	
		.4) 8.2kΩ electric safety edge	
		.5) No safety edge ("hold to run" close)	
0.3	Safety edge function during normal operation. (parameter 0.1 = 3 or 4)	.1) Stop and open the door for 2 seconds again after safety edge activation	X
		.2) Stop if safety edge is activated and only continue if the close button is pressed again.	
0.5	Safety edge function during fire alarm.	.1) Photocell off - Safety edge off.	X
		.2) Photocell off - Safety edge active. Stop if safety edge is activated and continue closing after the configured time (parameter 0.6).	
		.3) Photocell off - Safety edge active. Open completely if mains power is present. If mains power is not present, stop and then close again after the configured time (parameter 0.6).	
		.4) Photocell active - Safety edge off. Stop if Photocell is activated and continue closing after the configured time (parameter 0.6).	
		.5) Photocell active - Crush protection off Open completely if mains power is present. If mains power is not present, stop and then close again after the configured time (parameter 0.6).	
		.6) Photocell active - Safety edge active. Stop if photocell and/or safety edge is activated and continue closing after the configured time (parameter 0.6).	

Parameter	Description	Settings	
		.7) Photocell active - Safety edge active. Open completely if mains power is present. If mains power is not present, stop and then close again after the configured time (parameter 0.6).	
0.6	Delay activation of safety edge protection in case of fire	0 – 60 Seconds	3 sec.
0.7	Safety edge function within range pre-end switch	.1) Stop if safety edge is operated	X
		.2) Deactivate/ignore safety edge	
0.8	Return time after safety edge activation	.0) Fast	X
		.1)	
		.2)	
		.3) Slow	
0.9	Type End switch	.0) Automatic	X
		.1) DES 3.2 GFA (new protocol)	
		.2) DES GFA (old protocol)	
		.3) DES Kostal	
		.4) NES	

8.5 Parameter series 1, (end) position settings

Parameter	Description	Settings	
1.1	End position open	Select the desired door position and save using stop/ok button. Stop button on lid to cancel.	
1.2	End position closed	Select the desired door position and save using stop/ok button. Stop button on lid to cancel. Once end position closed has been modified, "Over-close" position must also be modified via parameter 1.7.	
1.3	Fine correction end position open	Increase or decrease open position. +/- 0 to 9.	
1.4	Fine correction end position closed	Increase or decrease closed position. +/- 0 to 9.	
1.5	Adjust pre-end position	Select the desired door position and save using stop/ok button. Stop button on lid to cancel.	
1.6	Fine correction pre-end position	Increase or decrease pre-end position. +/- 0 to 9.	
1.7	Adjust "over-close" DES	During programming, the "over-close" position is automatically matched to the end position closed. For another "over-close" position, select the desired door position and save using the stop/ok button. Stop button on lid to cancel.	
1.8	Fine correction "over-close" DES	Increase or decrease "over-close" position. +/- 0 to 9.	
1.9	Partial opening	Select the desired door position and save using stop/ok button. Stop button on lid to cancel.	

8.6 Parameter series 2, action settings

Parameter	Description	Settings	
2.1	Duration monitoring NES	1 to 240 seconds	120 sec.
2.2	Impulse function (parameter 0.1 = Automatic opening)	.1) Inactive during opening	X
		.2) Stop during opening	
2.3	Automatic close time in normal operation.	0 = Automatic close deactivated	X
		1 to 240 seconds	
2.4	Photocell function when counting down automatic close time in normal operation.	.0) Time is started again if the photocell is broken.	X
		.1) Once the photocell has been broken for longer than 1.5 seconds, the door will close again after 3 seconds irrespective of the remaining time.	
2.5	Number of re-openings during automatic close, and activation of safety edge	0 to 10 The total will be indefinite if this parameter is set to 0.	0
2.6	Programmable input	.1) Fire alarm test function	X
		.2) Switch operating buttons on/off	
		.3) Works as "mute" function	
		.4) Input for key switch to bring door back to intermediate position if this has overrun after power failure (only possible for DES). Please note!! Visually check the position of the door to see if any end positions have been passed.	
		.5) Software-based override slack cable/pass door contact (if the door has overrun into the emergency end switches, the override will remain active as long as the door remains in the emergency end position).	
		.6) Switch operating buttons lid on/off. (External controls remain active).	
2.7	Pre-warning close in normal operation	0 to 60 seconds.	0 sec.
2.8	Pre-warning close in case of fire, smoke, battery/power failure	0 to 60 seconds.	0 sec.
2.9	Deactivate photocell function for particular range if photocell is placed in the threshold. (Only for DES)	.0) Switch off	X
		.1) Switch on (place the door in the top position, go to parameter 2.9 and allow the door to move completely to the bottom 2x); controller will now remember the	

Parameter	Description	Settings	
		photocell position and ignore the photocell during closing from that point.	

8.7 Parameter series 3, emergency settings

Parameter	Description	Settings	
3.1	Choice end position door bottom during alarm/emergency in combination with NES	.1) Use normally closed end switch; deactivate end switch S6.	X
		.2) Use end switch (S6) as "Over-close".	
		.3) Use normally closed end switch and use (S6) as ES open (intermediate position) in case of fire.	
3.2	Autom. close time when using escape button during fire.	1 to 240 seconds.	1 sec.
3.3	Function "open" button during fire	.1) Deactivated.	X
		.2) Hold to run open and close.	
3.4	Extend FD function after FDC has been active.	0 to 240 seconds.	0 sec.
3.5	Number of closure attempts if safety edge/photocell operated during emergency.	0 to 10 The total will be indefinite if this parameter is set to 0.	0
3.6	Action if safety edge and/or photocell are not detected when the FDC, SDC or door close become active, in case of low battery voltage or loss of power.	.1) Ignore: door will close without Safety feature. Once safety edge is activated, the door will continue to close without safety feature after ≥ 120 sec.	X
		.2) Do not ignore: door will remain open for max. 120 sec. If the safety feature is still activated, the door will close without the safety feature.	
		.3) Do not ignore: door will remain open.	
3.7	Function during mains power failure	.1) Immediately close door.	
		.2) Close door if battery power is too low.	X
		.3) Only issue Warning. (door will close if batteries do not have enough capacity to keep door open).	
3.8	Function Escape button	.1) Always active.	X
		.2) Only active for Fire alarm input 2.	
		.3) Only active for Fire alarm input 1.	
		.4) Inactive.	

Parameter	Description	Settings	
3.9	function of safety edge and/or photocell after reaching the maximum number of attempts configured in parameter 3.5. (par. 3.5 > 0)	.1) Continue to close without safety edge.	X
		.2) Open again for 2 seconds and then stop (only possible if mains power is present).	
		.3) Only stop.	

8.8 Parameter series 4, warning settings

Parameter	Description	Settings	
4.1	Choice door movement in case of alarm/emergency. NES: extra end switch (S6) and continue closing after time configured in 4.2 (not possible if par. 3.1 is set to 2). DES: intermediate position par. 4.9.	.1) Door fully closed immediately.	X
		.2) Interim stop for extra end switch.	
4.2	Waiting time for interim stop. (Par. 4.1 = 2).	1 to 240 seconds.	1 sec.
4.3	Choice door movement in case of fire alarm. NES: partial opening extra end switch S6. (Par. 3.2 ≠ 2) DES: configure intermediate position in parameter 4.9. (Options 2 and 3 can only be selected if Par. 4.9 is configured)	.1) Fully close in case of fire alarm 1 and/or 2.	X
		.2) Half open in case of fire alarm 1 and fully closed in case of fire alarm 2.	
		.3) Half open in case of fire alarm 2 and fully closed in case of fire alarm 1.	
4.4	Choice door movement if mains power lost (Par. 4.3 = 2 or 3)	.1 NES) Remains at current position if door is not open at end position. Close to intermediate position if open at end position.	X
		.2 NES) Closes fully if it is below the position configured on S6.	
		.1 DES) Door remains stationary if it is below the position configured on 1.7.	X
		.2 DES) Door closes fully if it is below the	

Parameter	Description	Settings	
		configured position.	
4.5	Delay time response to start emergency/accident alarm.	0 to 10 minutes.	0 min.
4.6	Choice reset in case of fire alarm	.1) No reset needed.	X
		.2) Reset needed for fire alarm input 1.	
		.3) Reset needed for fire alarm input 2.	
		.4) Reset needed for fire alarm input 1 and 2.	
4.7	Delay time door release after reset.	0 to 240 seconds.	60 sec.
4.8	Activating half open in case of alarm/emergency. (Must only be set for DES, Par. 4.9)	.1) Deactivated; door opens fully when escaping during a fire.	X
		.2) Activated; when escaping during a fire, the door opens to the position configured in parameter 4.9.	
4.9	Position half open in case of alarm/emergency.	Use the buttons on the circuit board to open the door to the desired end position. Press OK button to confirm or press stop button on lid to cancel.	

8.9 Parameter series 5, output settings

Parameter	Description	Settings	
5.1	Function output 1 (terminals X 6)	.1) Switch off	X
5.2		.2) Activated during pre-warning in case of door movement.	
		.3) Only activated in case of door movement.	
		.4) Only activated in case of fire alarm or close for power failure, if this has been selected. (during pre-warning and door movement).	
		.5) Only activated in case of fire alarm, smoke alarm or low battery voltage if the door is moving.	
		.6) Activated in case of fire alarm/emergency.	
		.7) Test function for light curtain.	
		.8) Test function for wireless transfer system on safety edge protection.	
		.9) Battery error from power/charger.	
		1.0) Low battery voltage.	
		1.1) Safety edge activated/faulty.	
		1.2) Photocell safety feature activated.	
		1.3) Error message active.	
		1.4) End position open reached.	
		1.5) End position closed reached.	
		1.6) "Over-close" end position reached.	
		1.7) No mains power.	
		1.8) Safety chain motor activated.	
		1.9) Safety brake or slack cable/pass door contact activated.	
		2.0) Maintenance.	
	2.1) Buzzer (activated simultaneously with internal buzzer).		
	2.2) Activated upon activation fire alarm input 1 (with closed door).		
	2.3) Activated upon activation fire alarm input 2 (with closed door).		
	2.4) Activated upon activation fire alarm input 1 + 2 (with closed door).		

Parameter	Description	Settings	
		2.5) Obstacle detection; activated if the photocell and/or safety edge input is interrupted/activated for a configured time (parameter 5.4).	
5.3	Choice after deactivation fire alarm(s) (Terminals X 16)	.1) Door closes until an open button, sensor input or stop button is operated.	X
		.2) Door stops immediately.	
5.4	Time obstacle detection	1 to 60 minutes.	1 min.
5.5	Function LED/buzzer signal transmitter.	.1) For all error messages and fire alarm/emergencies. Only activate again after longer than 30 seconds for photocell and/or safety edge.	X
		.2) For all error messages and emergencies.	
		.3) Only for fire alarm/emergency.	
		.4) Off.	
5.7	Type fire alarm input 2	.1) 8.2kΩ resistor.	X
		.2) Potential-free NC contact.	
5.8	Reverse direction of rotation (motor with NES)	.1) Retain direction of rotation.	X
		.2) Reverse direction of rotation.	
5.9	Pass door/slack cable	.1) 5,1kΩ resistor	X
		.2) Potential-free NC contact.	

8.10 Parameter series 8, maintenance settings

Parameter	Description	Settings	
8.5	Number of cycles before maintenance (per 1,000 cycles, setting possible from 1,000 (= 1) to 99,000 (= 99))	1 to 99	
8.7	Maintenance counter	.1) Deactivated.	X
		.2) Activated; (message and close door when counter reaches 0)	
		.3) Activated; (message when counter reaches 0)	
8.9	Display maintenance cycle counter	Maintenance cycle counter is displayed. This counts down to 0 from the configured value. Upon reaching 0, a message is sent to perform maintenance.	

8.11 Parameter series 9, registration

Parameter	Description	Settings	
9.1	Cycle counter	Number of times door has opened. (cannot be reset)	
9.2	Last 20 error messages.	The last 20 error messages are displayed from the newest to the oldest. Interrupt display by pressing "menu stop/ok" button.	
9.3	Number of cycles after programming changes	The number of cycles are displayed since the last change in the menu.	
9.4	Software version	Software version is displayed.	
9.5	Reset to factory settings	.0) Do not perform reset and return to the menu.	
		.1) Perform reset, restart controller (press "menu stop/ok" button for 5 sec. to confirm.)	

9 (Error) Messages

9.1 Status messages

Request	Description	Recommendation/Explanation
E 1.1	Operation open active.	
E 1.2	Operation stop active.	
E 1.3	Operation close active.	
E 1.4	BMC input 1 active/interrupted or not yet reset.	Smoke alarm active/short circuit in cables
E 1.5	Escape button active.	
E 1.6	Test function active.	
E 1.7	BMC input 2 active/interrupted or not yet reset.	
E 1.8	Mute button active.	
C.S.	Maintenance cycle reached.	Perform maintenance on the door and configure par. 8.5 again. The LED on the lid will flash red/green alternately.

9.2 Error messages (for questions: +31 (0) 182 23 15 25 or service@metacon-next.com)

Request	Description	Recommendation/Explanation
F 1.3	Safety chain drive unit DES.	Thermo contact activated. Allow the drive to cool off. Safety brake activated (if connected to DES)
F 1.4	Input for slack cable/pass door contact activated.	Check cables, pass door/slack cable contact and 5 kΩ resistor connected to X12
F 1.5	Cable breakage smoke detector/remove smoke detector	Short circuit in connection cables of detectors; remove one of the detectors in the chain from the socket.
F 1.6	Input for safety brake activated.	Check switching contact and/or cables safety brake.
F 2.0	No safety edge present or safety edge faulty.	This message is shown if a decision has been made to automatically detect the safety edge. This message will appear once if the safety edge is not detected when starting up the controller; this can be lifted by fully opening the door. If a safety edge is connected, make sure it is connected correctly to X13. The eyes of opto sensors must see each other when the controller is started. A 1.2kΩ or 8.2kΩ resistor must be present in the safety edge when starting up the controller. Possibly manually configure the safety edge type via the menu.
F 2.1	Photocell activated.	The photocells have been broken. This could be attributed to the light beam being broken, a faulty photo cell and/or an error in the electric circuit. Check the following if this message persists: - Has the photocell been correctly aligned and is the lens clean. - Is the electric circuit connected to X11. Photocells not broken; circuit must be connected to X11 (terminals 3 and 4). If photocells are not used, place a wire bridge on X11 terminals 3 and 4.

Request	Description	Recommendation/Explanation
F2.2	During automatic closure, the door has reached the configured number of attempts (par.2.5)	Check if there is an obstacle in the door opening. If this is the case, remove the obstacle and enter a new close command. If there is no obstacle, check if the safety edge is still working correctly and if the pre-end switch closed is correctly configured.
F 2.4	8.2kΩ safety edge activated.	The 8.2kΩ safety edge has been activated; this could be attributed to an obstacle in the door opening. If there is no obstacle in the door opening, and this message continues to appear, check if the safety edge resistor on X13 (GND (X13-4) and 1.2kΩ/8.2kΩ (X13-2) input) is 8.2kΩ.
F 2.5	8.2kΩ safety edge faulty.	Check if the safety edge resistor in X13 (GND (X13-4) and 1.2kΩ/8.2kΩ (X13-2) input) is 8.2kΩ. Check the spiral cable for cable breakage.
F 2.6	1.2kΩ safety edge activated.	The 1.2kΩ safety edge has been activated; this could be attributed to an obstacle in the door opening. If there is no obstacle, and this message continues to appear, check if the safety edge resistor on terminal X13 (GND (X13-4) and 1.2kΩ/8.2kΩ (X13-2) input) is 1.2kΩ
F 2.7	1.2kΩ safety edge faulty.	Check if the safety edge resistor on X13 (GND (X13-4) and 1.2kΩ/8.2kΩ (X13-2) input) is 1.2kΩ. Check the spiral cable for cable breakage.
F 2.8	1.2kΩ safety edge test negative.	Check if the safety edge resistor on terminal X13 (GND (X13-4) and 1.2kΩ/8.2kΩ (X13-2) input) is 1.2kΩ. Check the spiral cable for cable breakage. Make sure that the pre-end switch has been correctly configured and if the safety edge rubber is pressed hard enough when the door is closed.
F 2.9	Opto sensor activated.	The safety edge opto or OSE light curtain have been broken. This could be attributed to an obstacle in the door opening. If this is not the case, and this message continues to appear, make sure that the eyes can still see each other. Also check the connections on X14 and X15 (+24Vdc and GND) and OSE output (X15-3) for the signal). Check if the sensors still work.
F 3.1	<p>NES: Safety chain drive unit activated (thermo contact or emergency end switches)</p> <p>DES: Emergency end switch activated.</p>	<p>NES: Check if the drive unit or the emergency end switches (red cams) have been activated. If this is the case, check if the open and close end switches are correctly configured. If the thermo contact of the drive unit is activated, wait until the drive unit has cooled down.</p> <p>DES: The door is beyond the range of the end switches. If the door has passed the end switch during a power cut, the door will open again under the hold to run mode after 5 seconds if the button is kept pressed; normal operation will be possible again once the door is back within the end positions.</p>
F 4.6	Light curtain has been activated.	The light curtain that is connected to X11 (terminal 3 and 4, or terminal 4 for a PNP/SSR light curtain) has been activated. Make sure that the light beams have not been broken. Check the cables for this input. Refer to the user manual of the light curtain to further diagnose the light curtain.

Request	Description	Recommendation/Explanation
F 4.7	Light curtain test negative.	For each close movement in normal operation, the test on the light curtain is activated by one of the “alarm”, “siren” or “limit switch closed at smoke” outputs. If the signal on the selected relay contact of X6 is not broken, this will be regarded as a negative test. The door can now only close “hold to run”. Check the connections of the light curtain and the light curtain itself. Please refer to the user manual of the implemented light curtain in order to diagnose the light curtain itself.
F 5.0	Software error.	Controller restart by software. Switch off power to controller and switch on power once again. Change the control circuit board if this message keeps returning.
F 5.1	Error in ROM memory.	ROM memory check failed. Restart the controller. Change the control circuit board if this message keeps returning.
F 5.2	Error in CPU.	CPU register test error. Switch off power to controller and switch on power once again. Change the control circuit board if this message keeps returning.
F5.3	Error in RAM.	RAM test error. Switch off power to controller and switch on power once again. Change the control circuit board if this message keeps returning.
F 5.4	Internal control error.	Plausibility error. Switch off power to controller and switch on power once again. Change the control circuit board if this message keeps returning.
F 5.5	DES (digital end switch) error.	Cannot communicate with Digital end switch. Check the connections of the digital end switch on X23. Swap the digital end switch of the drive unit if this is faulty.
F 5.6	Error in door movement.	Check the door mechanism. Check the phases to the drive unit (U-V-W) Check the rotation movement digital end switch. Door movement only still possible with internal push buttons. Note!! Door end positions may not be secure!
F 5.7	Error in direction of rotation.	The direction of rotation has changed since programming the end positions. Check if the door opens with the up button; if this is the case, use parameter 9.5 in the menu to restore the controller to factory settings. And re-program the end positions. If the drive unit runs in the wrong direction, swap the U and W connections in order to change the direction of rotation of the drive unit.
F 5.9	Duration control.	Maximum duration exceeded. Check the door mechanism. Check if the time that has been configured for parameter 2.1 is sufficient and configure again if necessary.
F 7.0	No mains power present.	This message is shown if mains power is not present. The controller will then only operate on the batteries. The door can no longer be operated. This will only start closing if the fire or smoke detector contact is activated or if a decision has been made to lower the door if the battery voltage is low. The door will also close if the batteries are completely empty. PLEASE NOTE: in this case, the safety features and end switches will not work.
F 7.1	Low battery voltage.	This message is shown if there is not enough voltage in the batteries. Make sure that mains power is present. If

Request	Description	Recommendation/Explanation
		this is present, check if the batteries are being charged. If the message persists, replace the batteries and/or the power/charger.
F 7.2	Error in charger.	This message is shown if the power/charger is no longer able to charge the batteries. Replace the batteries and/or the power/charger.
F 7.3	Batteries' impedance too high.	The internal resistance of the batteries is too high. Check the connection between the batteries and the power/charger. If this is as it should be, replace the batteries.
F 7.4	No batteries detected.	No batteries have been connected. Check the connection between the batteries and the power/charger. If this is as it should be, replace the batteries and/or the power/charger.
F 7.5	Error in rotating field 3-phase input when starting controller.	Possible solution. Change two phases on input X1 of the controller.
F 7.6	A phase is missing on the input when starting controller.	Possible solutions: For a 3-phase connection, check the phases on the input. Check fuses FS1, FS2 and FS3 on the circuit board. For a 1-phase motor. Check the phase on X1 L1 and the neutral on L2. Check FS1 and FS2. Remove mains power and battery power and re-connect them after 30 seconds.
F 7.7	Error in main relay.	The relay is jammed or there is no voltage in the relay output if it is activated when the motor operated. Possible solution: Check if all phases are present in the mains power. Check FS1, FS2 and FS3. Remove mains power and battery power and re-connect them after 30 seconds. If this is as it should be, replace the controller.
F 7.8	Error in inversion circuit.	Tested for each end position. This error message is generated if one of these relays is jammed. Possible solution: fully cut power to the controller, and start again. Swap control circuit board if the message reappears.
F 7.9	Internal hardware error.	The inputs with resistance detectors are tested each time when the end position is reached. Possible solutions: fully cut power to the controller, and start again. If this does not work, swap the control circuit board.
F 8.1	Internal error IO module 1 (optional).	Switch off power and switch it back on again. Replace the IO module if this does not work.
F 8.2	Communication error IO module 1 (only if I/O module connected).	Error in communication with the IO module. Check the cables between the IO module and the controller. Check if the terminating resistor on the module is activated if this is the last device on the bus. If this is as it should be, replace the IO module or controller.
F 8.3	Internal error IO module 2 (optional).	Switch off power and switch it back on again. Replace the IO module if this does not work.
F 8.4	Communication error IO module 2 (only if I/O module connected).	Error in communication with the IO module. Check the cables between the IO module and the controller. Check if the terminating resistor on the module is activated if this is the last device on the bus. If this is as it should be, replace the IO module or controller.

10 Configuration fire/smoke detector

10.1 FD (fire detection) function (alarm/emergency)

If the FDC (Fire Detection Contact) is activated, the door will close because the voltage to the electric brake on the drive unit will be cut. Under the default factory setting, the door will lower until it reaches the end switch close. If the door must descend past the end switch close or must stop at another position, the end switch (S6) must be used as an “over-close” end switch.

If communication between the controller and DES is lost on a controller with digital end switch DES, the door will close without end switches!

- The normal open button can be switched on or off via parameter 3.3 in case of alarm/emergency. If this button has been activated in the menu, the door will open in “hold to run” when it is pressed. The door will immediately close again when the open button is released.
- The fire detection function can be activated with a delay. This can be done via parameters 4.5 and 4.6. The door will only be closed after the configured time.
- A pre-warning can also first be given with a configured time for the ‘fire detection function’ and the ‘close in case of power failure or low battery voltage’ option. This time can be configured using parameter 2.8 (0 to 60 seconds).
- The fire detection function can be extended once the FDC input has closed again. This can be configured to between 0 and 240 seconds via parameter 3.4.
- An input is available for connecting the escape button. The door will open if this button is operated. This can be completely open, or the extra end switch can be used to configure an intermediate position so that the door opens halfway (set parameter 3.1 to 3).
- The door will close once the waiting time (1 to 240 seconds) configured in parameter 2.2 has passed. During the configured waiting time, the close button can be used to immediately close the door.
- The intermediate position can also be used to make an interim stop (parameter 4.1) if closing when the FDC contact is active. In this case, the door will first close to this position, and will wait for the time configured in parameter 4.2 before it continues to close.

10.2 Continue running if battery empty (only for digital end switch DES)

It is possible to raise the door again if it has gone past the end switches and has reached the emergency end switches (because the batteries were empty). This is only possible during normal operation by pressing the Up button on the circuit board for at least 5 seconds. After 5 seconds, the door will open in “hold to run” mode and can thus be placed back within the end positions.



PLEASE NOTE!

The end positions are not monitored in this function! Make sure that you release the button on time.



PLEASE NOTE!

The batteries must be replaced immediately if they have become too empty (deep discharge; this can be caused if mains power has not been connected to the controller for a long period of time).

10.3 Maintenance counter

Parameter 8.7 in the menu can be used to activate a maintenance counter. Parameter 8.5 can be used to configure the number of door openings (per 1,000) before a maintenance message is issued. When this counter reaches 0, the LED on the display will start flashing green (if there is no active error message) and the message C.S. will appear on the display.

10.4 Smoke gasket

The following settings are needed to control FirePro V4 fire doors with a smoke gasket:

- One of the potential-free contacts must be configured so that it is activated if the door is closed via the fire input(s) where the gasket must be inflated. This involves options 2.2 to 2.4, see parameters 5.1 and 5.2.
- Fire alarm(s) where the gasket must be inflated if the door is closed must be reset. This can be selected in parameter 4.6.
- A delay time must be configured for release following a reset, so that the gasket has enough time to retract. This can be configured in parameter 4.7. This time starts when the reset is activated (if the fire alarm(s) is/are no longer active). "Normal" door operation can only be resumed once this time has passed.
- The escape button can be deactivated in parameter 3.8. So that the door - in case of fire alarm where the gasket was inflated - cannot be opened and the gasket cannot be damaged as a result.

11 Signal transmitter P-cap

11.1 Definition

The signal transmitter P-CAP is an extension of the FirePro V4 to make the alarm visible and audible. This must be mounted in the vicinity of the door. The signal transmitter needs 10 minutes after switching on the supply voltage to fully charge. The signal transmitter, when fully charged, can give a sight and audible alarm for at least 60 seconds after a voltage failure. A 2nd lamp / buzzer can be connected to the signal transmitter.

The following parameters can be set on the FirePro V4:

Parameter	Definition	Instruction
5.5	Signal transmitter function	.1) For all error messages and fire alarm/calamity. Only with photocell and or safety edge Only activated after more than 30 seconds
		.2) For all error messages and calamities.
		.3) Only in case of fire alarm/calamity.
		.4) Off.

11.2 Connecting

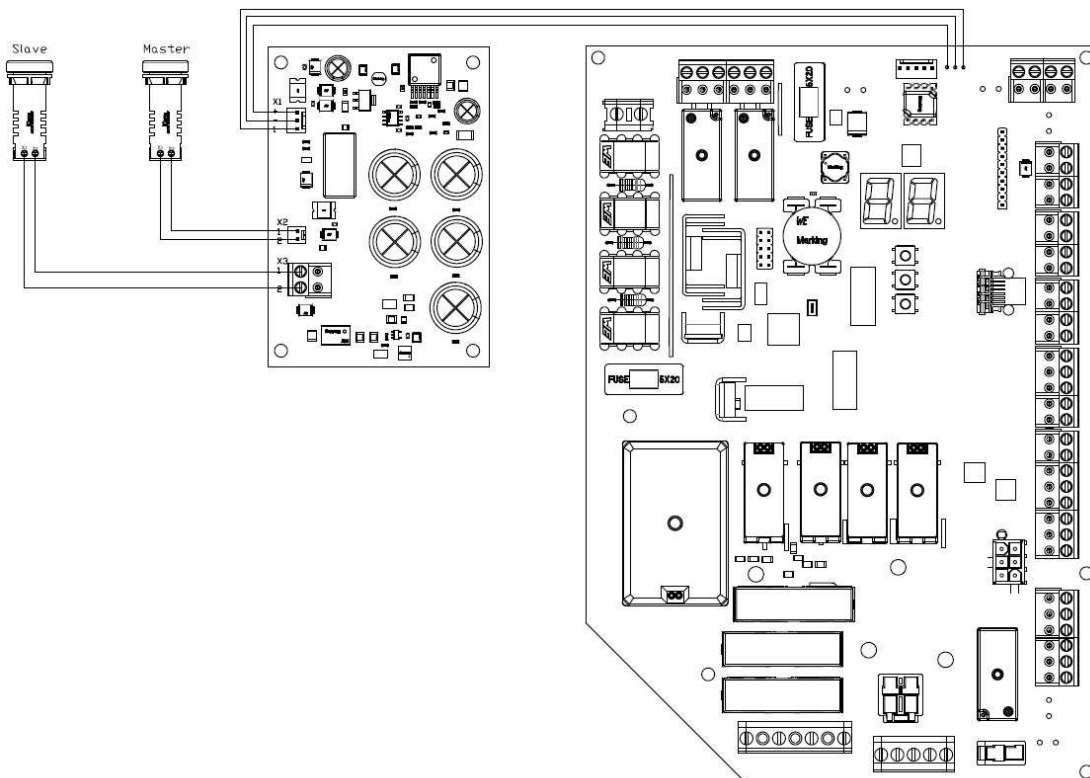

Signaler P-Cap		Firepro V4	
IN		Firepro V4	
X1+	+ 24 VDC	X9	1
X1 -	GND	X9	2
X1 1	Lamp/sirene	X9	3
OUT			
X2 1	Lamp/sirene		
X2 2	GND		
OUT			
X3 1	Lamp/sirene		
X3 2	GND		

11.3 Technical data:

Data	Explanation
Weight	270 g
Height	75 mm
Width	75 mm
Depth	100 mm
Maximum power	2,4 w
Maximum current	100 mA
Lamp/Buzzer	
Control voltage	24 Vdc
Control current	50 mA
Volume buzzer	80 dB
Frequency buzzer	2800Hz
Cable	
Execution	4 x 0,75 mm ²
Maximum length	25 meter
Protection class	IP 40
Ambient temperature	+5...+40°C
Relative humidity	Max. 93% (non-condensing)
Vibration	Vibration-free mounting (e.g. brick wall)

12 Maintenance

In order to guarantee effective operation, the user must perform an inspection on the whole system, including all components, every 3 months.

When doing so, confirm that the door functions completely during normal operation and closes as required in case of emergencies and/or loss of power. This inspection must be documented and stored by the user.

Children may not clean the device and cannot perform user maintenance without supervision!

The complete system must also be inspected by a professional installation engineer at least once a year. The annual inspection must be documented and stored by the installation engineer. A copy of the annual inspection report must also be left with the user.

12.1 Preventive maintenance

12.1.1 Maintenance plan

Table 6 maintenance plan

Component	Action	Interval	Done by
Visual inspection controller	Inspection	Monthly	User
Visual inspection controller	Inspection	Yearly	Installation engineer
Visual inspection drive unit	Inspection	Monthly	User
Visual inspection drive unit	Inspection	Yearly	Installation engineer
Visual inspection peripherals	Inspection	Monthly	User
Visual inspection peripherals	Inspection	Yearly	Installation engineer
Functional inspection controller	Inspection	Monthly	User
Functional inspection controller	Inspection	Yearly	Installation engineer
Functional inspection drive unit	Inspection	Monthly	User
Functional inspection drive unit	Inspection	Yearly	Installation engineer
Functional inspection Safety components	Inspection	Monthly	User
Functional inspection Safety components	Inspection	Yearly	Installation engineer
Functioning Fire alarm with mains power	Inspection	Monthly	User
Functioning Fire alarm with mains power	Inspection	Yearly	Installation engineer
Functioning Fire alarm without mains power	Inspection	Monthly	User
Functioning Fire alarm without mains power	Inspection	Yearly	Installation engineer
Battery	Replace	annually	Installation engineer

12.1.2 Maintenance instructions

The instructions below must be followed when performing maintenance::

- 1 Visual inspection controller: Make sure that the controller has no damage or shortcomings.
- 2 Make sure that the mains power cable is not damaged. If this is damaged, replace it with an original cable from the manufacturer.
- 3 Visual inspection drive unit: Make sure that the drive unit has no damage or shortcomings.
- 4 Visual inspection peripherals: Make sure that the peripherals have no damage or shortcomings.
- 5 Functional inspection controller: make sure that the door opens, closes and stops when the appropriate buttons are operated.
- 6 Functional inspection drive unit: Check if the drive unit runs in the correct direction when the relevant button is operated, and make sure it does not make any strange noises.
- 7 Functional inspection Safety components: Operate the installed safety components (photocell, light curtain, safety edge protection, etc.) while the door is moving. The door must stop and go back when this is done.
- 8 Functioning Fire alarm with mains power: Use the FirePro controller and fire alarm system to simulate a fire alarm with an open door while there is mains power; the door must close.
- 9 Functioning Fire alarm without mains power: Remove mains power, simulate a fire alarm with open door; the door must close.
- 10 Replace batteries: Replace the batteries after the year stipulated in the user manual.

12.1.3 Cleaning the device



WARNING

Never use compressed air, scouring sponges, abrasive cleaning products or aggressive liquids like benzene or acetone to clean the device.



WARNING

Do not use a high-pressure spray jet to clean the device or the area around the device.

13 Decommissioning and disposal

13.1 Decommissioning

To decommission the controller, the mains power must be cut and the poles of the batteries must be disconnected.

Performing activities on the controller while it is still being powered is perilous and can cause serious injury!



WARNING

Only use the controller for the purpose for which it was designed. See 1.1 Intended use on page 7.



WARNING

The controller can only be managed by people who have read the user manual and are thus sufficiently familiar with the functioning, operation, maintenance, etc. of the controller, as described in this user manual.



DANGER

It is forbidden to remove, bypass or deactivate safety features and protective devices.

13.2 Disposal

The symbol below (crossed-out waste bin) means that the end user must dispose of the product separately from household waste in accordance with legislation in the country where the product is being used.

In this case, pay specific attention to removing the batteries and disposing of them separately.

The aim of the concerned symbol is to minimize electrical and electronic household appliances from being disposed of as “non-sortable waste”, so that harmful effects on health and the environment can be avoided wherever possible.



Appendices

5. EC declaration or Declaration of incorporation

As referred to in machinery directive 2006/42/EC for partly completed machinery, appendix II.1.B.

As referred to in the EMC directive 2014/30/EU

RDA bv, located at Spoorakkerweg 6 in 5071 NC Udenhout, hereby declares that the product mentioned below complies with the above-mentioned EC directive and is only intended to be incorporated into a door system as described in the user manual.

Fire-Pro

(Fire-pro, fire door controller, Fire-Pro V4, sr. no.:, year of construction:,)

Implemented (parts of) European standards:

EN 12453:2017+A1:2021	Industrial, commercial and garage doors and gates - Safety in use of power operated doors - Requirements
EN 12978:2003+A1:2009	Industrial, commercial and garage doors and gates. Safety devices for power operated doors and gates. Requirements and test methods.
EN 60335-1:2012 + AC:2014 + A11:2014 + A1:2019 + A14:2019	Household and similar electrical appliances - Safety - Part 1: General requirements.
EN 61000-6-2:2019	Electromagnetic compatibility (EMC) Part - 6-2: Generic standards. Immunity standard for industrial environments.
EN 61000-6-3:2021	Electromagnetic compatibility (EMC) - Part 6-3: Generic standards - Emission standard for equipment in residential environments.

We will supply information about this partly completed machine if a reasoned request is received from the national authorities.

Authorized representative for compiling the technical documents.

(EU address internal)

Ing. Teun Tielemans

Responsible for documentation

This product is a partly completed machine as referred to in the EMC directive 2006/42/EU and is intended to be incorporated into other machines (or other partly completed machines/installations) or to be connected with them in order to form a complete machine, as referred to in the directive. This product may thus only be operated if it has been confirmed that the fully completed machine/installation, in which the product is incorporated, complies with the provisions in the above-mentioned directive.

Udenhout 17-05-2022

Corné Ribbers
Managing Director

Signature

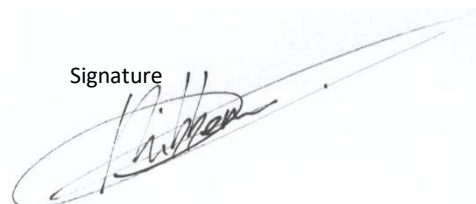

Essential health and safety requirements concerning the design and construction of the machine according to the Machinery Directive 2006/42/EC

appendix I	implemented / complied with	appendix I	implemented / complied with	appendix I	implemented / complied with
General principles					
1	no	1.5.11	n/a	3.6.1	n/a
2	no	1.5.12	n/a	3.6.2	n/a
3	no	1.5.13	n/a	3.6.3	---
4	no	1.5.14	n/a	3.6.3.1	n/a
	no	1.5.15	n/a	3.6.3.2	n/a
essential health and safety requirements					
1	---	1.5.16	no	4	n/a
	---	1.6	---	4.1	---
1.1	---	1.6.1	no	4.1.1	n/a
1.1.1	no	1.6.2	no	4.1.2	---
1.1.2	no	1.6.3	yes *1	4.1.2.1	n/a
1.1.3	no	1.6.4	yes	4.1.2.2	n/a
1.1.4	no	1.6.5	n/a	4.1.2.3	n/a
1.1.5	no	1.7.1	no *2	4.1.2.4	n/a
1.1.6	no	1.7.1.1	yes	4.1.2.5	n/a
1.1.7	no	1.7.1.2	n/a	4.1.2.6	n/a
1.1.8	n/a	1.7.3	n/a	4.1.2.7	n/a
1.2	---	1.7.4	no *1	4.1.2.8	---
1.2.1	yes *1	1.7.4.1	no *1	4.1.2.8.1	n/a
1.2.2	yes	1.7.4.2	no *1	4.1.2.8.2	n/a
1.2.3	yes	1.7.4.3	no	4.1.2.8.3	n/a
1.2.4	---	2	n/a	4.1.2.8.4	n/a
1.2.4.1	yes	2.1	---	4.1.2.8.5	n/a
1.2.4.2	no	2.1.1	n/a	4.1.3	n/a
1.2.4.3	n/a	2.1.2	n/a	4.2	---
1.2.4.4	n/a	2.2	---	4.2.1	n/a
1.2.5	yes	2.2.1	n/a	4.2.2	n/a
1.2.6	yes *1	2.2.1.1	n/a	4.2.3	n/a
1.3	---	2.2.2	---	4.3	---
1.3.1	no	2.2.2.1	n/a	4.3.1	n/a
1.3.2	no	2.2.2.2	n/a	4.3.2	n/a
1.3.3	n/a	2.3	n/a	4.3.3	n/a
1.3.4	no	3	n/a	4.4	---
1.3.5	n/a	3.1	---	4.4.1	n/a
1.3.6	no	3.1.1	n/a	4.4.2	n/a
1.3.7	no	3.2	---	5	n/a
1.3.8	n/a	3.2.1	n/a	5.1	n/a
1.3.8.1	n/a	3.2.2	n/a	5.2	n/a
1.3.8.2	no	3.2.3	n/a	5.3	n/a
1.3.9	no	3.3	n/a	5.4	n/a
1.4	---	3.3.1	n/a	5.5	n/a
1.4.1	no	3.3.2	n/a	5.6	n/a
1.4.2	---	3.3.3	n/a	6	n/a
1.4.2.1	no	3.3.4	n/a	6.1	---
1.4.2.2	no.	3.3.5	n/a	6.1.1	n/a
1.4.2.3	n/a	3.4	---	6.1.2	n/a
1.4.3	yes *1	3.4.1	n/a	6.2	n/a
1.5	---	3.4.2	n/a	6.3	---
1.5.1	yes	3.4.3	n/a	6.3.1	n/a
1.5.2	yes	3.4.4	n/a	6.3.2	n/a
1.5.3	yes	3.4.5	n/a	6.3.3	n/a
1.5.4	yes *1	3.4.6	n/a	6.4	---
1.5.5	yes	3.4.7	n/a	6.4.1	n/a
1.5.6	no	3.5	---	6.4.2	n/a
1.5.7	no	3.5.1	n/a	6.4.3	n/a
1.5.8	no	3.5.2	n/a	6.5	n/a
1.5.9	no	3.5.3	n/a		
1.5.10	n/a	3.6	---		

*1: additional conditions included in the assembly manual;

*2: other language agreed

*3: CE marking not applied

6. Spare parts

Part number	Description	Additional information
	FirePro V4, control circuit board - HWx.xx	
	Power/charger	24 Vdc
	battery	12 Vdc, 5.2 Ah
	Panel key	
	Indicator/buzzer	
	P-cap V2	
	Velcro	400 x 30 mm, flame retardant
	Fuse F1	6.3 Ampère Slow
	Fuse F2	6.3 Ampère Slow
	Fuse F3	6.3 Ampère Slow

7. Installation details (to be filled in by the installation engineer)

Details of the Door	
Order number	
Serial number	
Location	
Date of Installation	
Details Manufacturer	
Name	
Address	
Telephone number	
Email	
Website	
Details installation engineer	
Name	
Address	
Telephone number	
Email	
Website	
Details Controller	
Manufacturer	
Product number	
Serial number	
Software version	
Replacement date Batteries	
Details Drive unit	
Manufacturer	
Product number	
Serial number	
Details Safety features	
Manufacturer	
Product number	
Serial number	

8. Maintenance sheet

Date	Done by	Maintenance done

Your installation engineer:

Metacon-Next B.V. | Zuidbaan 450 | 2841 MD Moordrecht | T +31 (0) 182 23 15 25 | E service@metacon-next.com |

